

THIN Solar Beacons LED Traffic Signs



Solar Power Unit

- Low cost and easy installation
- Smart solar charger
- Long lasting lithium LifePO4 Battery
- No wire needed

Thin Lightweight LED Traffic signs

- Ergonomic design
- No wire needed
- Low maintenance

Piezoelectric Technology

- Low cost and easy installation
- Smart solar charger
- No wire needed
- Activation by push-button
- Calendar Scheduling
- Free data on activation
- Battery level Indicator

Plug & Play

- No wire needed
- Easy programming

	Pages	Products
Awareness	4-6	THIN Stop LED Sign
	7-10	THIN Amber or Red Flashing Beacon
	11-14	THIN Dual Flashing Beacon
	15-17	THIN Dual Flashing Beacon Sign
Crosswalk	18-22	THIN Rectangular Rapid Flash Beacon (RRFB) + Activation Options
Parking	27-30	THIN LED Parking Management Sign F.O.B Activation + Activation Options
	32-33	THIN Dynamic LED Parking Sign
Speed	34-37	THIN-12 Radar Speed Feedback Sign
	38-39	THIN-12 Dolly Portable Radar Speed Feedback Sign
	40-41	THIN Portable Radar Feedback Sign
	42-48	THIN SSA-3 Portable Radar Speed Feedback Sign
		Technologies
	49-50	THIN Lightweight LED Traffic Sign
	51-55	Solar panel All-In-One

Leader of advanced Technologies for a smart and active mobility electronic traffic calming systems.

Our advanced technological solutions are meticulously crafted to optimize safety for all road users and reduce infrastructure costs to do so. We are dedicated to aiding planning engineers in their mission to enhance road safety by offering innovative products and services in the age of urban densification and increased road sharing.

Helping communities reach their goal of vision Zero - eliminating all traffic fatalities and severe injuries - in order to ensure safe, healthy equitable mobility for all.

Striving to develop innovations that fulfill the demands of the present while upholding the integrity of our resources and environment for the benefit of future generations.



THIN Stop LED Sign

When approaching the stop line, the bright LED STOP sign immediately draws drivers' attention to the sign by emphasizing the octagonal contour (a universally recognized shape) using integrated 24/7 (40) flashing LEDs.

With its solar panel and batteries, the LED STOP sign is autonomous for a period of at least three (3) days without sunlight, even in winter. The LED STOP is designed to retrofit and be installed on all types of poles.

Solar Power Supply



Easy Installation on standard posts



Increases Driver Awareness



Increase Safety

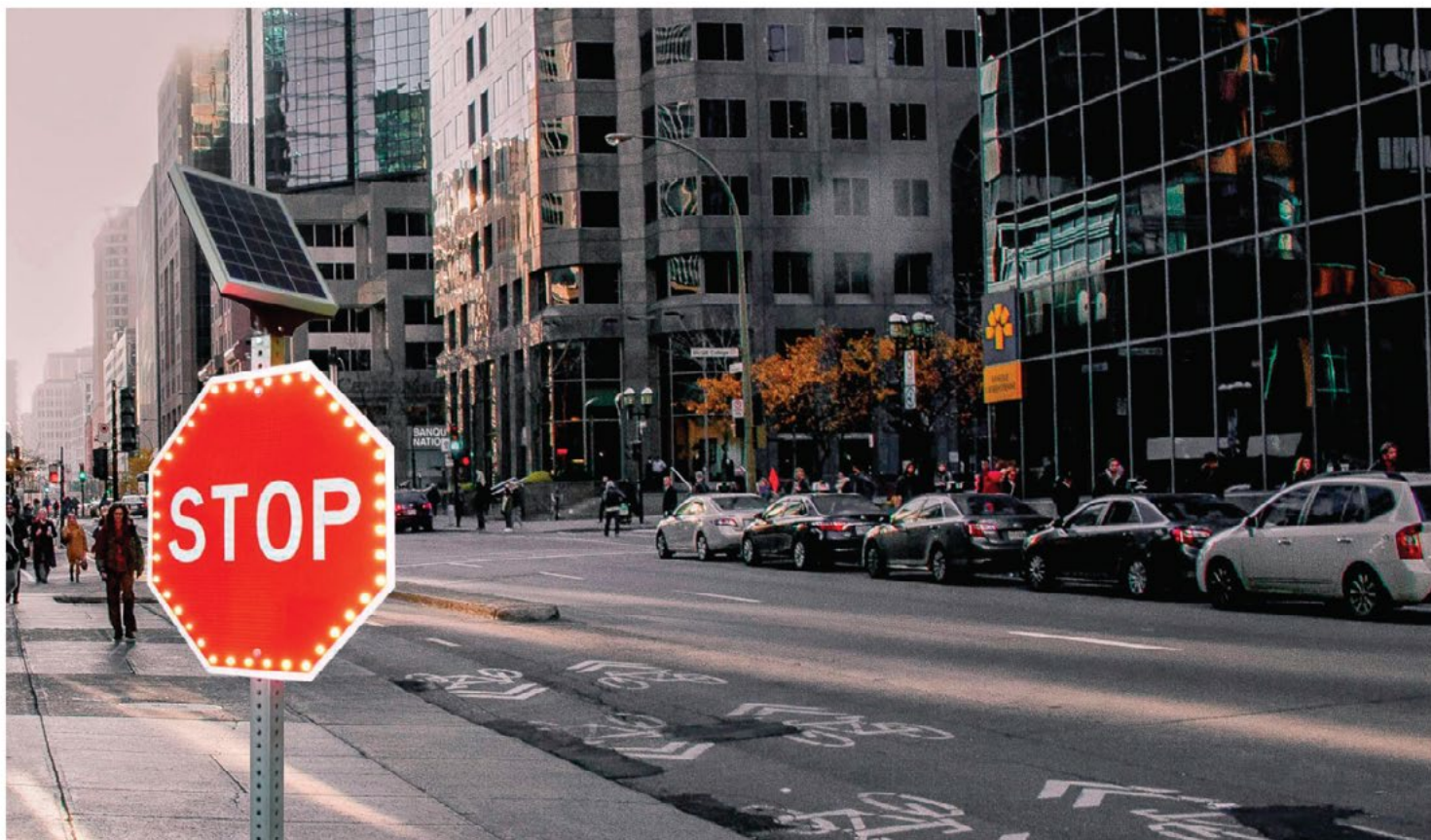

THIN Stop LED Sign

2+
years
waranty

Solar Power Unit (All-in-one)

Solar Panel	10 Watts Monocrystalline
LifePo4 Battery	12.8V - 9Ah
Solar Charger	MPPT, 10 A, IP67
Connector	10mm OD, Male, 6 in, IP67
Operating temperature	-40 to + 165oF (-40 to +74oC)
Weight	4.5 kg (10 lb)





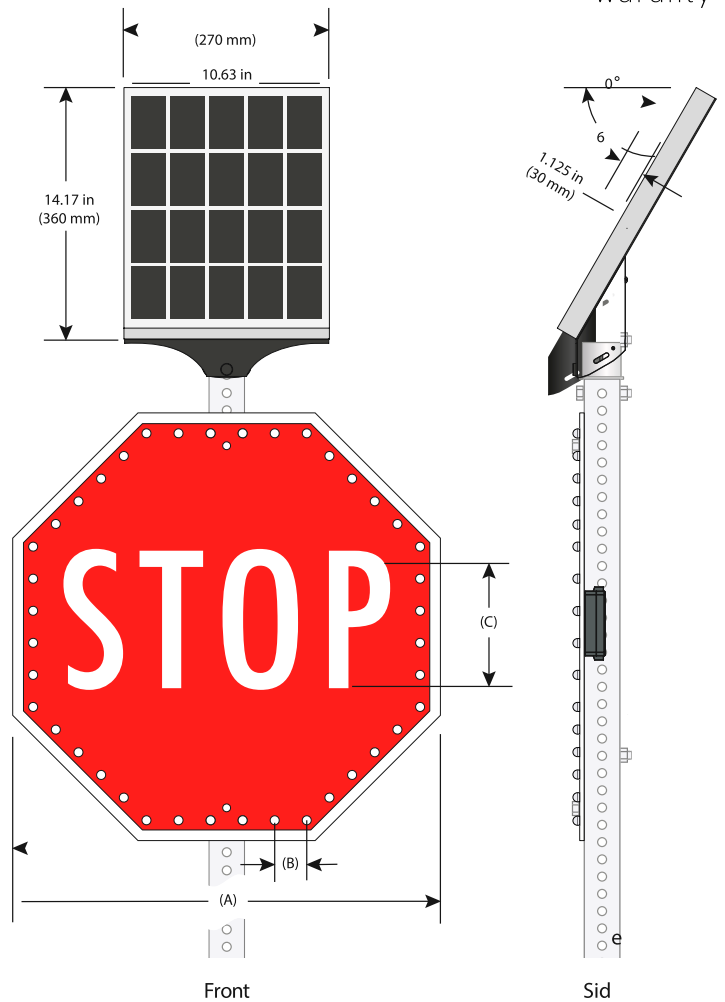

LED Stop Sign

Standard	MUTCD, TAC, TOME V, SIECA
Color	Red 626 nm (4000K)
Led angularity	30 degrees
Life expectancy	100 000 hours
Luminous Intensity	100 cd day - 30 cd night
Auto-dimming	Variable based on ambient light
Voltage In	10,8 to 15 VDC
Max. Power @ 12 V	8 Watts
Connector	10mm OD, Male, 6 in, IP67
Flash Patterns	0,1 - 0,2 - 0,5 sec or tri-flash
Flash Rate	60 per minute
Activation	24/7, night only, on-demand
Default setting	0,1 sec, 24/7
Back Plate	Aluminium 5052-H38
Reflective Sheeting	3M™ Diamond grade Type XI
Lens	UV resistant transparent Polycarbonate
Waterproof rating	IP65
Operating Temperature	-40 to +131°F (-40 à +50°C)



THIN Stop LED Sign



Products	Box Size - Weight	HSS Code
  Assembly Kit # 37531 24 in (600 mm) Thin Led Stop Sign, 10W solar power unit	32 x 32 x 8 in - 21 lb	8530.90
  Assembly Kit # 37532 30 in (750 mm) Thin Led Stop Sign, 10W solar power unit	32 x 32 x 8 in - 26 lb	8530.90
  Assembly Kit # 39490 36 in (900 mm) Thin Led Stop Sign, 10W solar power unit	40 x 40 x 8 in - 32 lb	8530.90

Activation Option

 Activation # 38129 Software for configuration or night only activation (USB Dongle + Software)	Included in kit box	N/A
---	---------------------	-----

Included with Assembly Kit : Installation hardware for 2" Telespar post, 2-3/8" round pole, U-Post or streetlight pole. Two (2) years Limited Warranty against defects in workmanship and materials.

THIN Amber or Red Flashing Beacon

The leading cause of roadway accidents in North America is distracted driving. The addition of the Smart Flashing Beacon will help prevent accidents in critical areas such as intersections, crosswalks and school zones by attracting attention to traffic signs.

With high-intensity LED lights, the single flasher beacon catches the driver's attention and ensures the visibility of signs, thus improving road safety.

Discrete, light and thin design



Easy Installation on standard posts



Increases Driver Awareness



Increase Safety



THIN Amber or Red Flashing Beacon

Solar Power Unit (All-in-one)

Solar Panel	30 Watts Monocrystalline
Battery	12.8V - 14Ah - LifePo4
Solar charger	MPPT, 10 A, IP67
Connector	10mm OD, Male, 6 in, IP67
Operating temperature	-40 to + 165oF (-40 to +74oC)
Weight	7.7 kg (17 lb)

Flashing Beacon

Beacon Size	8 in (200 mm) or 12 in (300 mm)
Standard	ITE VTCSH-STD 2005 EN 12352 L8M Class
Color	Amber 590 nm
Life expectancy	100 000 hours
Luminous Intensity	650 cd day - 200 cd night
Auto-dimming	Variable based on ambient light
Voltage In	10,8 to 15 VDC
Max. Power @ 12 V	8 Watts
Wireless Communication	Encrypted 902 MHz, up to 100m (300')
Connector	10mm OD, Male, 6 in, IP67
Flash Patterns	0,1 - 0,2 - 0,5 sec, tri-flash or WW+ S
Flash Rate	60 per minute
Activation	24/7
Default setting	0,1 sec, 24/7
Back Plate	Aluminium 5052-H38, 0,08 in (2 mm)
Sheeting (Black)	3M™ Scotchcal™
Reflective Sheeting (Yellow)	3MTM Prismatic High intensity Type IV
Visor	Aluminium, black painted textured
Lens	UV resistant transparent Polycarbonate
Waterproof Rating	IP65
Operating Temperature	-40 to +131°F (-40 à +50°C)
Weight	3 lb (1,4 kg)

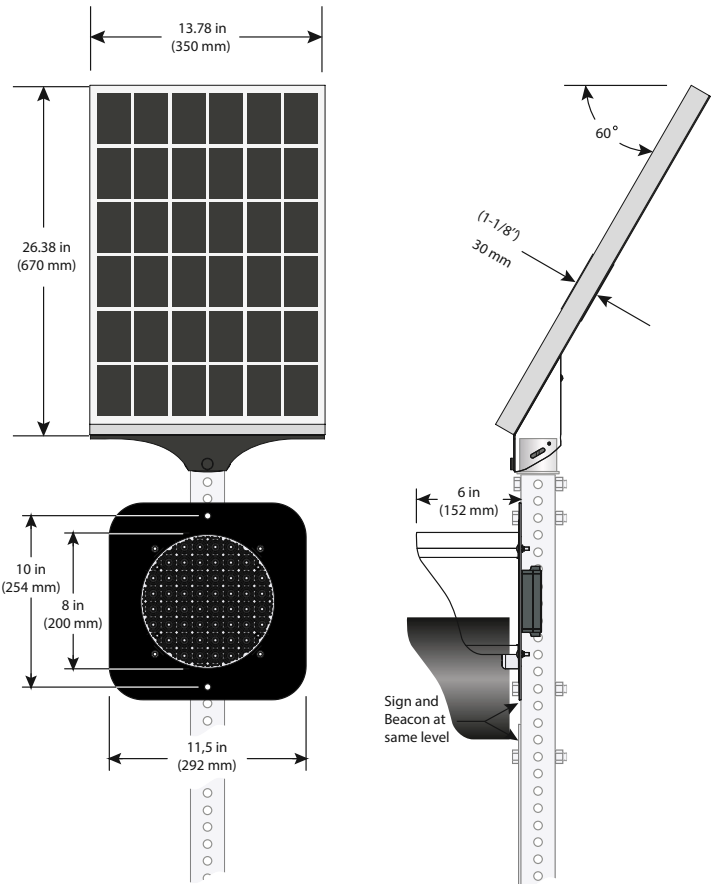

Single



Single Back-to-back



Dual Vertical



Dual Horizontal

THIN Amber or Red Flashing Beacon









Solar Power Unit (All-In-One)





THIN Amber or Red Flashing Beacon



Product	Box Size - Weight	HSS Code
 Assembly Kit # 37704 Single-Side Kit for Ontario crossing, 30W solar power unit	18 x 28 x 14 in - 21 lb	8530.90
 Assembly Kit # 37737 Single-Side Kit for Ontario crossing, 30W solar power unit	18 x 28 x 14 in - 21 lb	8530.90
 Assembly Kit # 37706 Single-Side Kit set of two (2) for Ontario crossing, 30W solar power unit	18 x 28 x 14 in - 26 lb	8530.90
 Assembly Kit # 37738 Single-Side Kit set of two (2) for Ontario crossing, 30W solar power unit	18 x 28 x 14 in - 26 lb	8530.90
 Assembly Kit # 37705 Single Flashing Beacon, red, black background, 30W solar power unit	18 x 28 x 14 in - 21 lb	8530.90
 Assembly Kit # 37707 Dual Flashing Beacon, red, black background, 30W solar power unit	18 x 32 x 14 in - 26 lb	8530.90

Activation Options

 Activation # 38129 Software for configuration or night only activation (USB Dongle + Software)	Included in kit box	N/A
 Activation Option # 36463 Wireless and battery free Remote Control	Included in kit box	N/A

Included with Assembly Kit : Installation hardware for 2" Telespar post, 2-3/8" round pole, U-Post or streetlight pole. Two (2) years Limited Warranty against defects in workmanship and materials.

THIN Dual Flashing Beacon

Driver inattention is the number one cause of road accidents in North America. The school zone flashing beacon, with its ultra-bright LEDs, captures drivers attention at crosswalks, school zones and critical traffic intersections.

The 8" Dual Flashing Beacon also serve an educational purpose, reinforcing existing road signs, with customizable flashing patterns!

Discrete, light and thin design



Easy Installation on standard posts



Increases Driver Awareness



Increase Safety



THIN Dual Flashing Beacon

Solar Power Unit (All-in-one)

Solar Panel	30 Watts Monocrystalline
Battery	12.8V - 14Ah - LifePo4
Solar charger	MPPT, 10 A, IP67
Connector	10mm OD, Male, 6 in, IP67
Operating temperature	-40 to + 165oF (-40 to +74oC)
Weight	7.7 kg (17 lb)

Flashing Beacon

Beacon Size	Two (2x) 200 mm (8 in) Amber or Red LEDs
Standard	ITE VTCSH-STD 2005
Auto-Brightness	Various Stages of Brightness for Day or Night (can be manually disabled)
Controller	Built-in
Controller Input Voltage	9.6 to 14 VDC
Connector	Snap-in, Overmolded IP67 Connector, 10 mm OD
Flash Patterns	MUTCD (0.5 sec ON, 0.5 sec OFF), Solar Power Mode or Rapid Flash
Beacon Control	Wigwag or Simultaneous
Operation	24 hrs, Night Only or Optional Activation
Temperature	-40 to +74°C (-40 to +165°F) 24 hrs – Wigwag – Solar Power Flashing Pattern Mode (0.2 sec ON) 3M High Intensity Prismatic D 4956-09
Reflective Sheeting	ASTM type IV
Sign	3 mm (.125") Aluminum 5052-H38
Visors	Aluminum, Textured Black Powder Coated
Lens	UV Stabilized Clear PVC
Environmental Protection	IP67

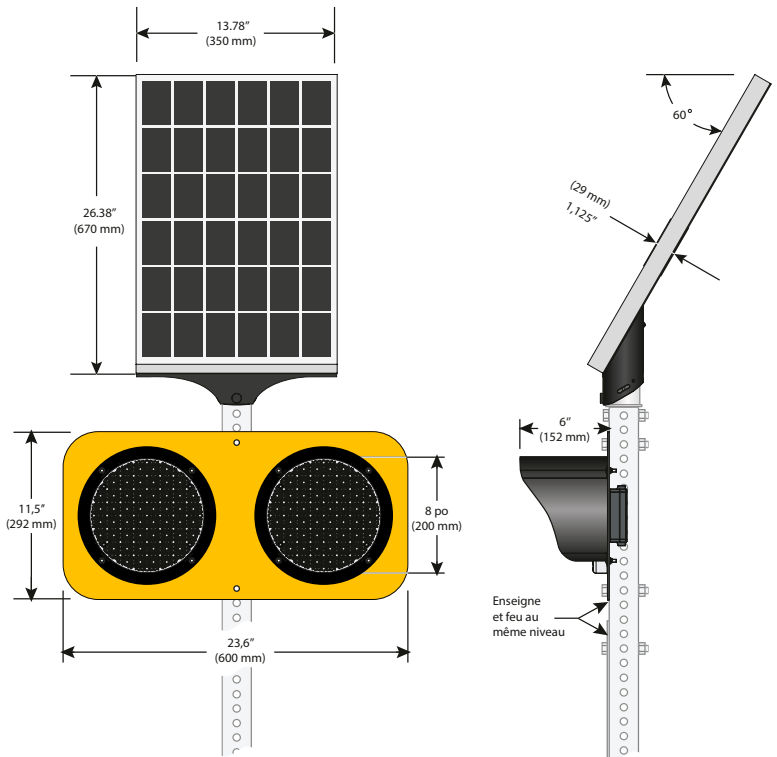

Piezoelectric technology

Each electronic sign has a smart control that allows custom programming based on usage. The smart controller can determine the type of operation (day, night, 24h, push button), the type of flashing (0.1 sec, 0.2 sec, 0.5 sec, Tri-Flash, WW + S and more) and pairing between the button and the controller.

Wireless communication has never been easier. Programming is easily done using PC software. This software also allows the programming of the internal calendar for activations according to a schedule. There is also a photocell on the smart controller to avoid dazzling drivers at night.

Our technology is wireless, without batteries and maintenance free. This technology provides communication between sign and activation systems such as : push-button, free-standing push-button, FOB or programmable time frame operation schedule. This system to suit your specific needs.



Battery Free
No maintenance required



Data Recording
Every event logged





Easy Pairing
Easy on-site wireless connection





THIN Dual Flashing Beacon



Product	Box Size - Weight	HSS Code
 Assembly Kit # 37742 Single-Side Kit set of two (2) for Ontario crossing, 30W solar power unit	18 x 28 x 14 in - 21 lb	8530.90
 Assembly Kit # 37741 Single-Side Kit set of two (2) for Ontario crossing, 30W solar power unit	18 x 28 x 14 in - 21 lb	8530.90

Activation Options

 Activation # 38129 Software for configuration or night only activation (USB Dongle + Software)	Included in kit box	N/A
 Activation Option # 36463 Wireless and battery free Remote Control	Included in kit box	N/A

Included with Assembly Kit : Installation hardware for 2" Telespar post, 2-3/8" round pole, U-Post or streetlight pole. Two (2) years Limited Warranty against defects in workmanship and materials.

THIN Dual Flashing Beacon Sign

The leading cause of roadway accidents in North America is distracted driving. The addition of dual flashing beacons will help prevent accidents in critical areas such as intersections, crosswalks and school zones by attracting attention to traffic signs. With high-intensity LED lights, the single flasher beacon catches the drivers' attention and ensures the visibility of signs, thus improving road safety.

Solar Power Supply



Easy Installation on standard posts



Increases Driver Awareness



Increase Safety



THIN Dual Flashing Beacon Sign

Solar Power Unit (All-in-one)

Solar Panel	30 Watts Monocrystalline
Battery	12.8V - 14Ah - LifePo4
Solar charger	MPPT, 10 A, IP67
Connector	10mm OD, Male, 6 in, IP67
Operating temperature	-40 to + 165oF (-40 to +74oC)
Weight	7.7 kg (17 lb)

Dual Flashing Beacon (24 x 52)

Beacon Size	Two (2x) 200 mm (8 in) Amber or Red LEDs
Standard	ITE VTCSH-STD 2005
Auto-Brightness	Various Stages of Brightness for Day or Night (can be manually disabled)
Controller	Built-in
Controller Input Voltage	9.6 to 14 VDC
Connector	Snap-in, Overmolded IP67 Connector, 10 mm OD
Flash Patterns	MUTCD (0.5 sec ON, 0.5 sec OFF), Solar Power Mode or Rapid Flash
Beacon Control	Wigwag or Simultaneous
Operation	24 hrs, Night Only or Optional Activation
Temperature	-40 to +74°C (-40 to +165°F) 24 hrs – Wigwag – Solar Power Flashing Pattern Mode (0.2 sec ON)
Reflective Sheeting	3M High Intensity Prismatic D 4956-09
Sign	ASTM type IV
Visors	3 mm (.125") Aluminum 5052-H38
Visors	Aluminum, Textured Black Powder Coated
Lens	UV Stabilized Clear PVC
Environmental Protection	IP67

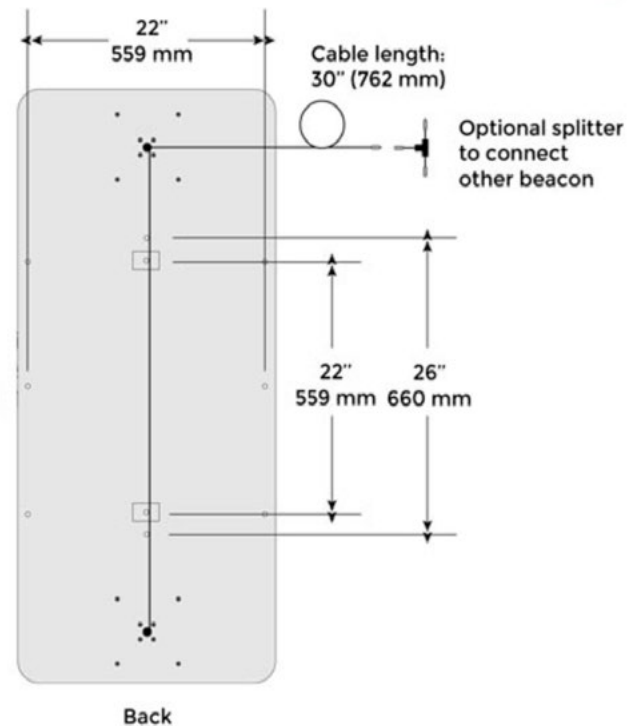
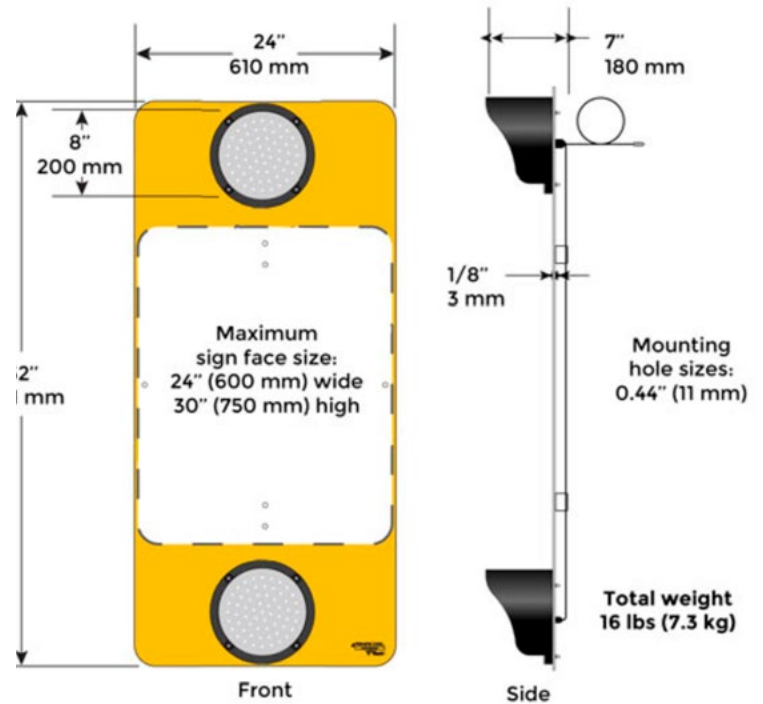

THIN Dual Flashing Beacon Sign

2⁺
years warranty



Vertical or horizontal
Installation



All-in-one Solar Power Unit



120-240 VAC Electric cabinet with battery

Power supply options



Add a reflective or standard traffic sign



or



WIG-WAG MODE

SYNC MODE

Programmable flashing pattern









#TD-CD20AJ



#TD-CD20AN

Amber or Red LED Sign

Product	Box Size - Weight	HSS Code
  Assembly Kit # 37754 Dual Flashing Beacon Sign, amber, black background, 30 W solar power unit	28 x 54 x 8 in - 52 lb	8530.90
  Assembly Kit # 38184 Dual Flashing Beacon Sign, amber, yellow background, 30 W solar power unit	28 x 54 x 8 in - 52 lb	8530.90
  Assembly Kit # 37754 Dual Flashing Beacon Sign, red, black background, 30 W solar power unit	18 x 32 x 14 in - 32 lb	8530.90

Activation Options

 Activation # 38129 Software for configuration or night only activation (USB Dongle + Software)	Included in kit box	N/A
 Activation Option # 36463 Wireless and battery free Remote Control	Included in kit box	N/A

Included with Assembly Kit : Installation hardware for 2" Telespar post, 2-3/8" round pole, U-Post or streetlight pole. Two (2) years Limited Warranty against defects in workmanship and materials.

THIN Rectangular Rapid Flash Beacon (RRFB)

As mentioned in the updated June 2018 safe transformation for every pedestrian countermeasure technical sheet from the US Department of Transportation (FHWA).

RRFB can reduce pedestrian crashes by 47%. It also says that multiple lanes create challenges for pedestrian crossing at unsignaled locations. RRFB can make crosswalks and/or pedestrians

Discrete, light and thin design



Easy Installation on standard posts



Wireless and piezoelectric activator



Increase Safety

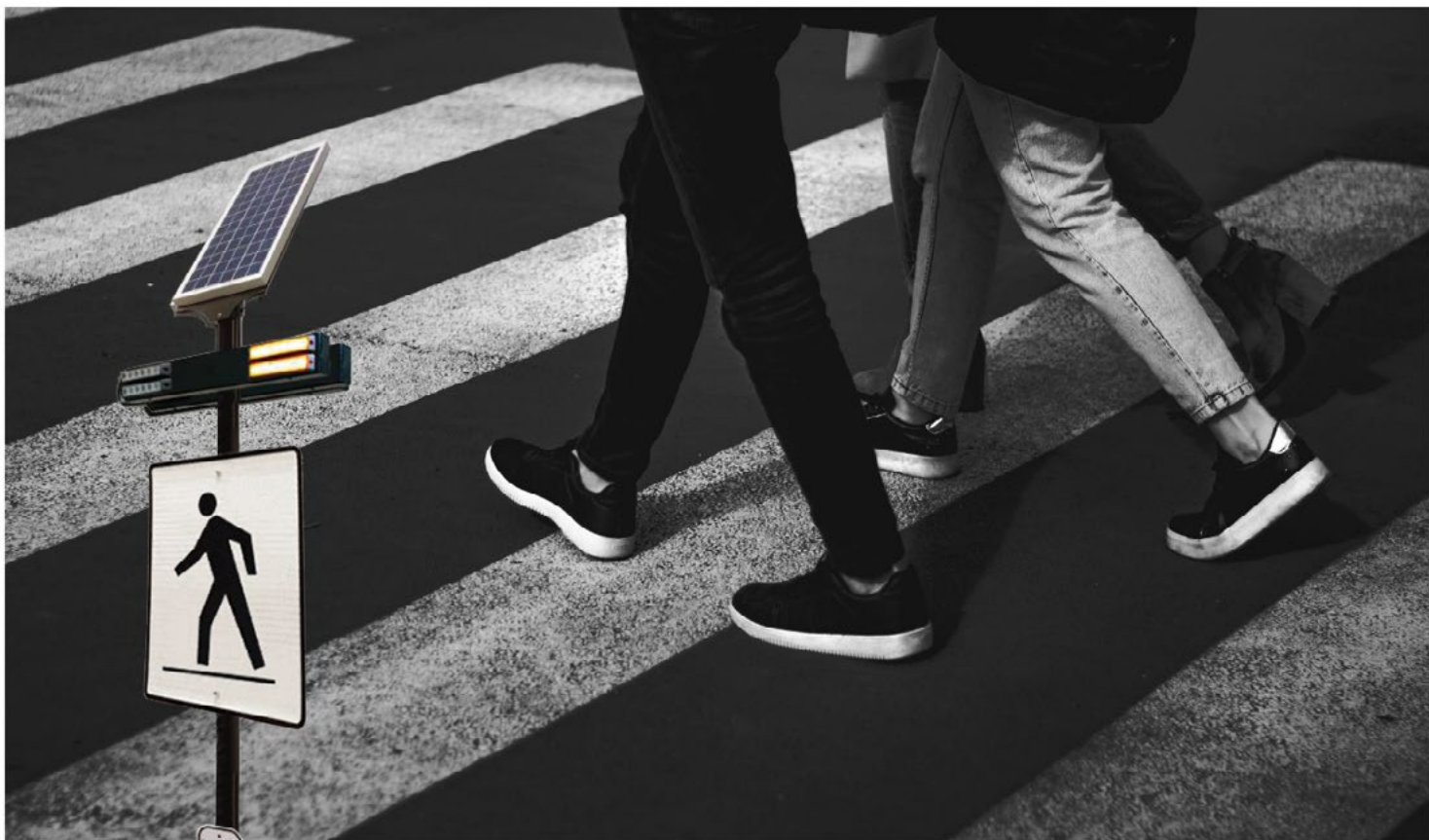

THIN Rectangular Rapid Flash Beacon (RRFB)

Solar Power Unit (All-in-one)

Flasher size	3 in x 6,25 in (72 x 159 mm)
Standard	SAE J595 class1
Color	Amber
Lens	UV resistant clear Polycarbonate
Life expectancy	Visibility 100 000 hours
Auto-dimming	Variable based on ambient light

Flashing Beacon

Flasher size	3 in x 6,25 in (72 x 159 mm)
Standard	SAE J595 class1
Color	Amber
Lens	UV resistant clear Polycarbonate
Life expectancy	Visibility 100 000 hours
Auto-dimming	Variable based on ambient light
Voltage In	10,8 to 15 VDC
Max. Power @ 12 V	15 Watts
Wireless communication	Encrypted 902 MHz
Wireless Range	Up to 100m (300') free field
Connector	10mm OD, Male, 6 in, IP67
Flash Patterns	WW+S, BLOCK or 2-5 (MUTCD)
Flash Rate	60 per minute
Activation	On demand
Default Setting	WW+S, On-demand
Rectangular Housing	Aluminium Black or Yellow Painted
Waterproof rating	IP65
Operating Temperature	-40 to +131°F (-40 à +50°C)
Weight	6,75 lb (3,1 kg)

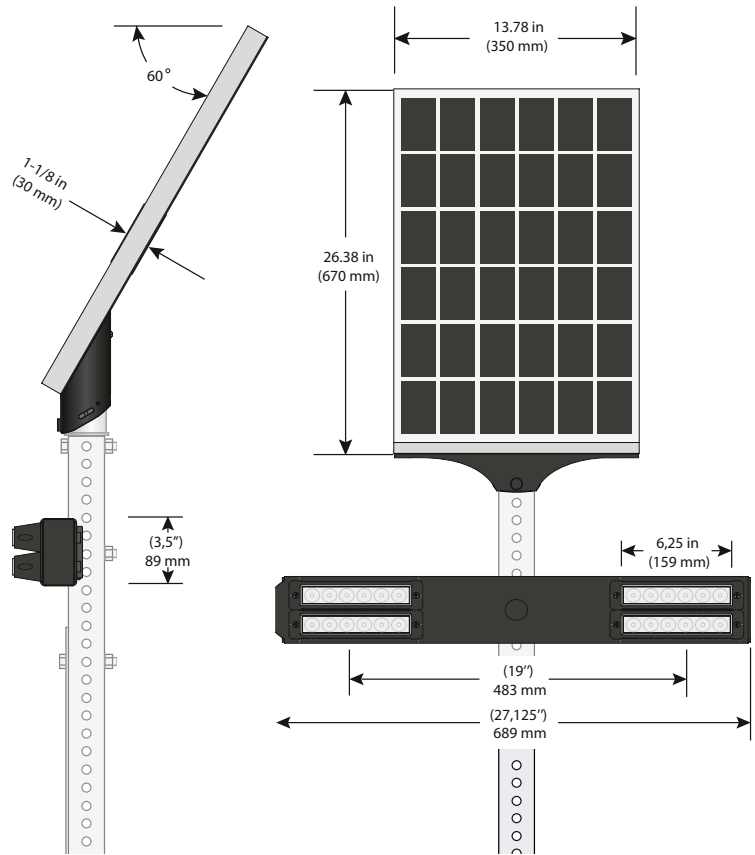

Solar Power Unit (All-In-One)

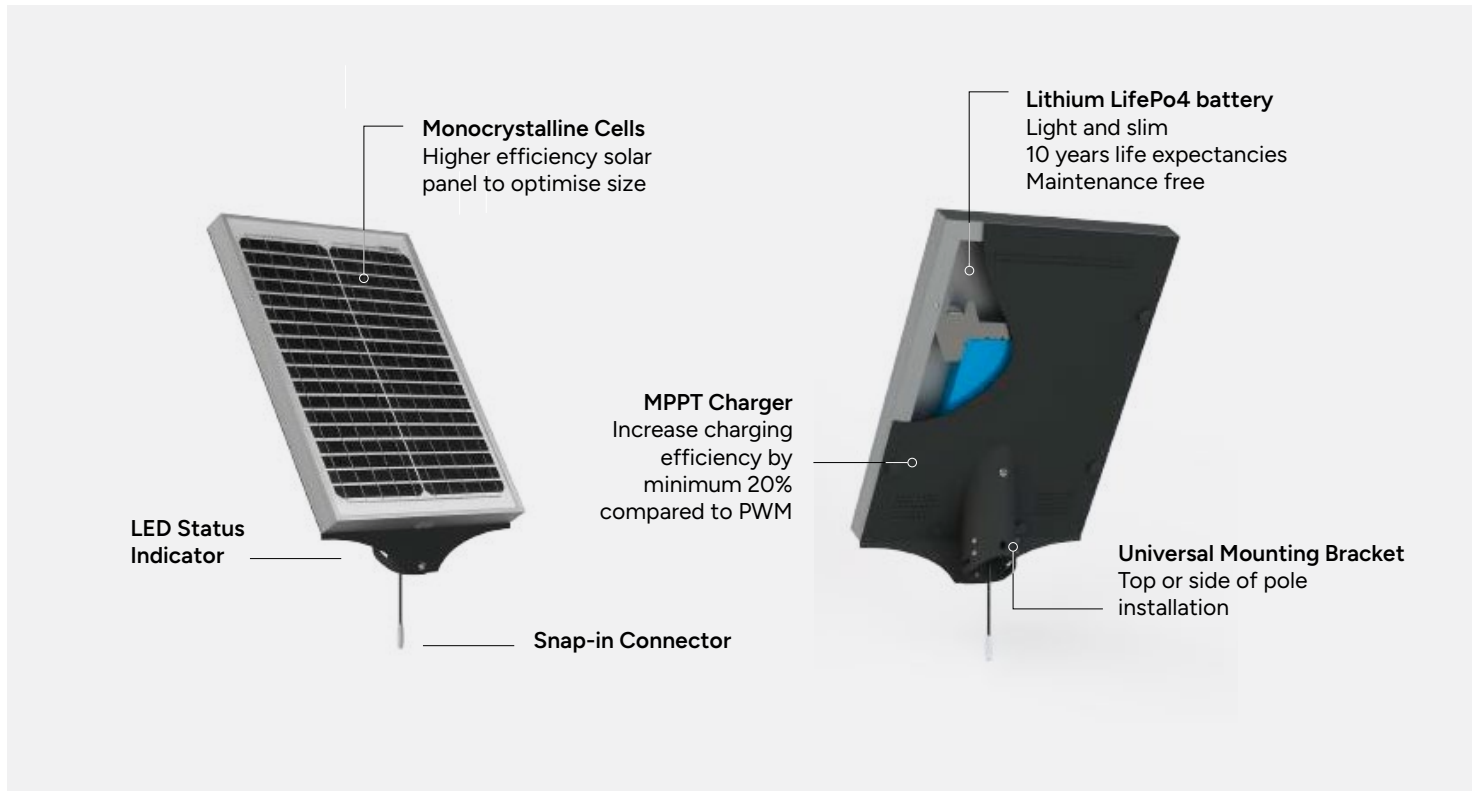

THIN Rectangular Rapid Flash Beacon

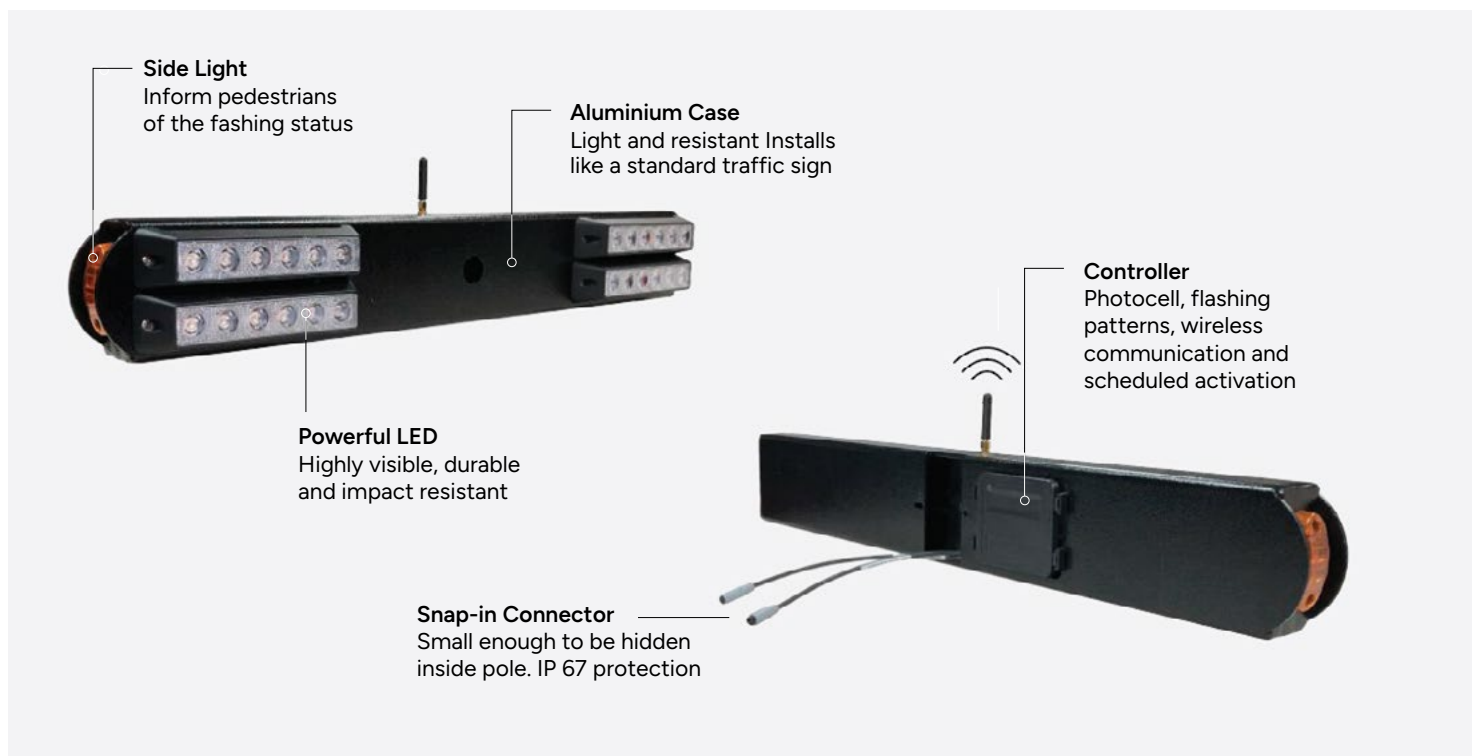

Piezoelectric technology

Each electronic sign has a smart control that allows custom programming based on usage. The smart controller can determine the type of operation (day, night, 24h, push button), the type of flashing (0.1 sec, 0.2 sec, 0.5 sec, Tri-Flash, WW + S and more) and pairing between the button and the controller.

Programming is easily done using PC software. This software also allows the programming of the internal calendar for activations according to a schedule. There is also a photocell on the smart controller to avoid dazzling drivers at night.

Our technology is wireless, without batteries and maintenance free. This technology provides communication between sign and activation systems such as : push-button, free-standing push-button, FOB or programmable time frame operation schedule. This system to suit your specific needs.



 **Battery Free**
No maintenance required

 **Data Recording**
Every event logged

 **Easy Pairing**
Easy on-site wireless connection

OPTION
FOB



INCLUDED
Power supply options



Solar



Electric

OPTION
Pole Push-button











OPTION
Motion sensor



THIN Rectangular Rapid Flash Beacon (RRFB)



Product		Box Size - Weight	HSS Code
	Assembly Kit # 37744 Single-Side Kit set of two (2) crossing, 30W solar power unit	32 x 18 x 9 in - 40 lb	8530.90
	Assembly Kit # 38899 Single-Side Kit set of two (2) crossing, ACDC	32 x 18 x 9 in - 40 lb	8530.90
	Assembly Kit # 37746 Double Side Kit set of two (2) crossing, 30W solar power unit	32 x 18 x 9 in - 40 lb	8530.90
	Assembly Kit # 38902 Double Side Kit set of two (2) crossing	32 x 18 x 9 in - 40 lb	8530.90
Activation Options			
	Activation # 38129 Software and Dongle - Add this item to set calendar schedule \ Button pairing and crossing time \ modify light intensity & Flashing pattern	Included in kit box	N/A
	Activation Option # 36463 Wireless remote control - Color Blue	Included in kit box	N/A
	Activation Option # 37173 Wireless push button on 34" Flexible Post - Canada, Ontario Standard	10 x 10 x 36 in - 9 lb	8530.80
	Activation Option # 36886 Pedestrian Sensor activation for 2-3/8" pole	5 x 3 x 2 in - 1 lb	8530.90

Included with Assembly Kit: Installation hardware for 2" Telespar post, 2 3/8" round pole, U-Post or streetlight pole, 30 in (760 mm) Male/female extension for dual unit. Smart USB Dongle required to change configuration of the RRFB. Two (2) years Limited Warranty against defects in workmanship and materials.

Wireless and Without Battery

Push Button Piezoelectric

Introducing our revolutionary piezoelectric Push Button, a wireless and battery-free remote controller designed to revolutionize your control experience. With a simple push, this innovative device harnesses mechanical energy through cutting-edge magneto-resistive technology, effortlessly converting it into ample electrical power to transmit radio signals to your device.

Say goodbye to cumbersome batteries and hello to seamless control. Our Push Button empowers you to manage a variety of Traffic LED devices with ease. Lightweight and built to withstand shocks, it seamlessly integrates into any environment as a standard traffic sign. Experience convenience and reliability like never before with the piezoelectric Push Button.

Discrete, light
and thin design



Easy Installation
on standard posts



Wireless and
piezoelectric
activator



No battery
required



Wireless and Without Battery

Push Button Piezoelectric

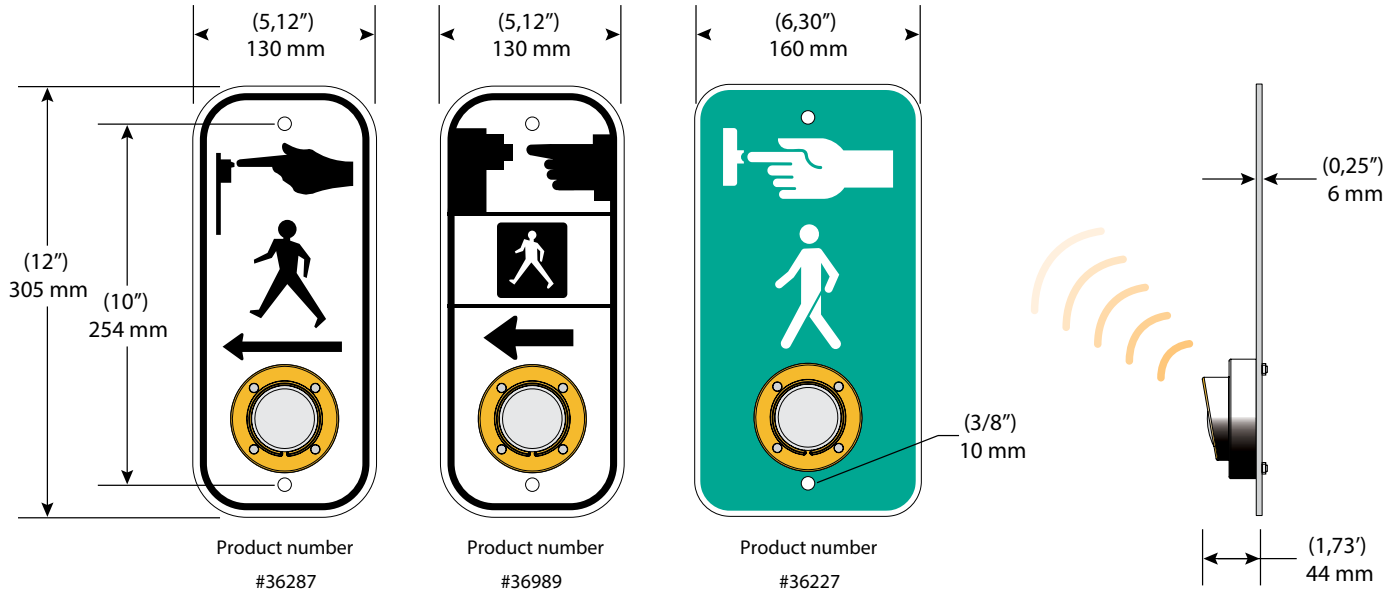

Material

Sign	6mm (0.25") White Polycarbonate
Decal	3M High Intensity Prismatic D
Environmental Protection	4956-09 ASTM type IV IP54
Weight	1,5 lbs (0,7 kg)

Shipping & Warranty

Box Size	305 x 203 x 75mm (12x8x3") Weight: 2lbs (0,9kg)
Warranty	2 years Limited Warranty for defects in workmanship and materials

Electrical Component

Push button	Round 3" OD Typical Movement Push button (ADA and MUTCD Compliant)
Energy	Create energy with a motion generator (no battery)
Wireless Communication	Encrypted message, 902 MHz band, low power
Transmission Range	Up to 100 m free field
Operating Temperature	-40°F to + 165°F (-40°C to +74°C)

You may be interested

Receiver/Transceiver for LED Sign
#36262



2-3/8" Round Post Bracket
#36262



Banding Bracket
#32901



Hardwares for 2 Telespart post
#36286



Hardwired Pedestrian Sensor

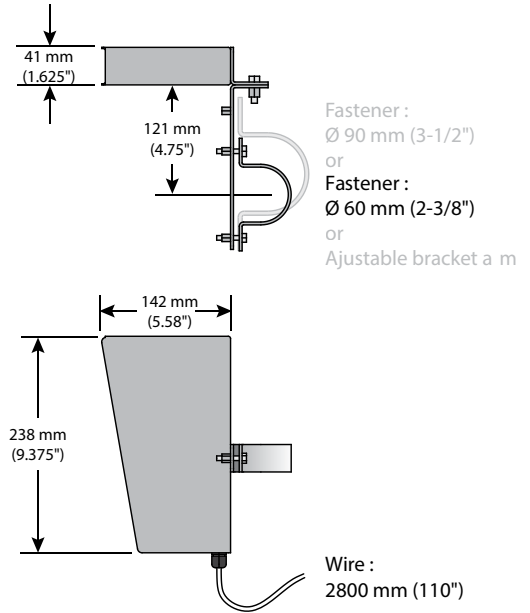
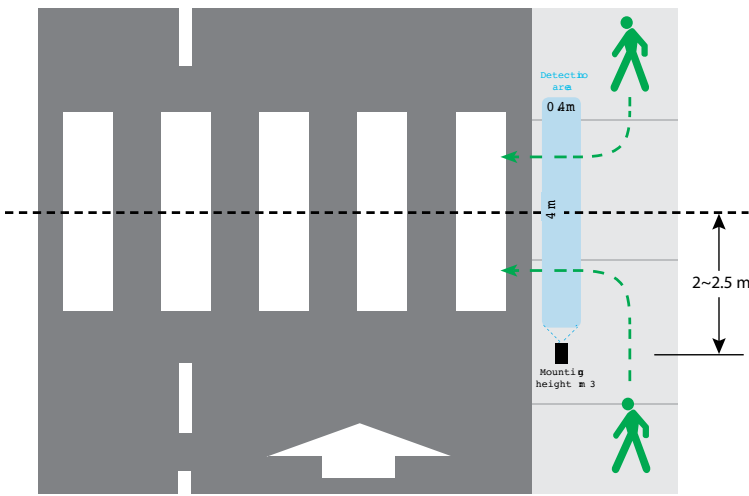

Product Number

#36886 : Ø 60 mm (2-3/8") fastener

#36738 : Ø 90 mm (3-1/2") fastener

Electrical Components

Sensor	Active Infrared Detection
Detection Area	400 mm x 4000 mm (16"x 158")
Sensor Orientation	360° Horizontal and Vertical
Range	3 m (10')
Power Supply	12 to 24 VDC
Power Consumption (12 V)	110 mA
Operation	Relay Output Pedestrian Activation
Connector	Dupont 1P, Flasher compliance
Activation Delay	1 second
Operational Temperature	-40 to +50°C (-40 to +131°F)

Optional
 1 to 2 m Adjustable Arm for 2-3/8" Round Pole #36845

Optional
 1 to 2 m Adjustable Arm for 3"+ Round Pole #36855

Materials

Box	Aluminum, grey painted
Sensor	ABS
Sensor Orientation	IP54
Range	Stainless Steel
Power Supply	1 kg (2,2 lb)

Shipping

Box Size	305 x 178 x 127 mm (12 x 7 x 5")
Weight	5 lb (2.2 kg) 2 detectors per box

Installation

- Included Installation Hardware for 2-3/8" Round Pole
- Optional, #36536 for Installation on 3-1/2" Round Pole
- Optional, Arm #36845 for Installation on 2-3/8" Round Pole
- Optional, Arm #36845 for Installation on 3"+ Round Pole

Warranty : 2 year Limited Warranty for defects in workmanship and materialsTwo (2) years limited warranty on defects for parts and workmanship

Wireless and Without Battery

Free Standing Push Button Bollard

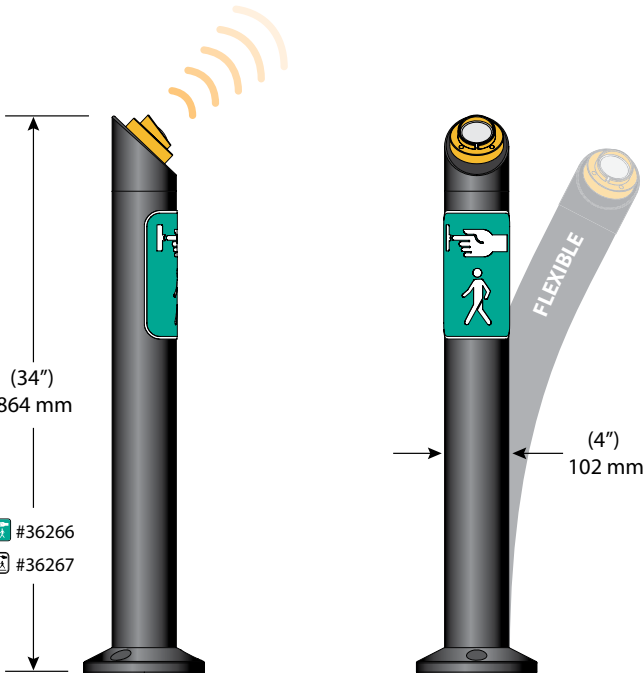

Our Free standing push button bollard is a wireless and battery-less remote controller mounted on a flexible post. The mechanical energy created by pushing the button is transformed, via a revolutionary magneto-resistive generator, in enough electrical energy to send a radio message to the controlled device. The push button allows control of any kind of Traffic LED device.

Lightweight and shock resistant, the post push button bollard can be installed anywhere closer to pedestrians. Requires transceiver # 36262.

DECAL



I-395-1



ID-21-L/R

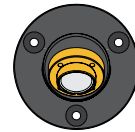

Mounting hole sizes: (0,5") 13mm

Material

Beacon Lens	Hard flexible Polyurethane 102mm OD - 10 mm wall
Standard	3M High Intensity Prismatic D 4956-09 ASTM type IV
LEDs Life Expectancy	IP65
Luminosity	7,6 lbs (3,5 kg)
Color	

Electrical Components

Push button Energy source	Round 3" OD Typical Movement push button (ADA and MUTCD Compliant)
Wireless communication	Motion generator (no battery)
Transmission Range	Encrypted message, 902 MHz band, low power up to 100 m free field
Operating temperature	-40oF to + 165oF (-40oC to +74oC)

Required
Receiver/Transceiver
for LED sign
#36262



Optional
Concrete Screws
#35198



Shipping

Box Size	2 lbs (0,9kg)
Weight	8lbs(3,6kg)

Warranty : 2 year Limited Warranty for defects in workmanship and materials

THIN LED Parking Management Sign F.O.B Activation

The thin smart parking management sign is made for maintenance and winter parking management. Thanks to wireless communication and activation, your operators will be able to efficiently manage your signage, which will greatly reduce maintenance operations.

Quickly and clearly informing citizens is a priority and the implementation of the thin sign provides short-term savings on management costs as well as staff mobilization, which are important factors in envisioning a smart city.

Two (2) Power Sources available



Easy Installation on standard posts



Wireless activation



Night only (option)



THIN LED Parking Management Sign

Materials

Reflective Sheeting	3M high-intensity prismatic D 4956-09 ASTM type IV
Panel	2 mm (.08") Aluminum 5052-H38
Color	Aluminum, Black Powder Coated
Lens	UV Stabilized Clear PPMA
Life expectancy	IP67
Auto-dimming	1.8 kg (4 lb)

Electrical Components

Beacon Lens	200 mm (8 in) or 300 mm (12 in)
Standard	MTQ – Book V
LEDs Life Expectancy	50,000 hrs
Luminosity	8 po = 11 cd Day – 44 cd Night 12 po = 170 cd Day – 70 cd Night
Color	Orange 605 nm Wavelength
Power Consumption @ 12 V	1.44 W Day – 0.5 W Night (0.2 sec Flash)
Controller	Built-in
Controller Input Voltage	10.8 to 15 VDC
Connector	Snap-in, Over molded IP67 Connector, 10 mm OD
Flash Patterns	Up to 100m (300') free field
Connector	10mm OD, Male, 6 in, IP67
Flash Patterns	MUTCD (0.5 sec) or Solar Panel Mode (0.2 sec)
Operation Modes	24 hrs, Night Only or Optional Activation
Operational Temperature	-40 to +55°C (-40 to +131°F)

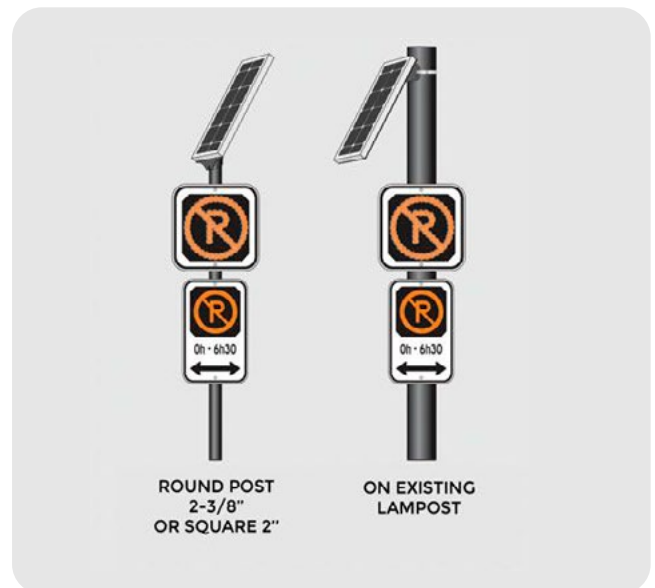
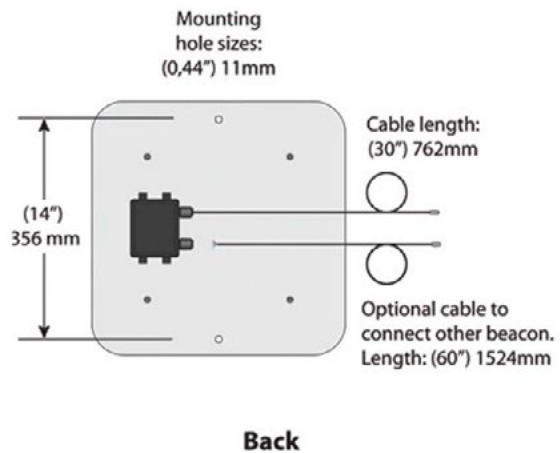
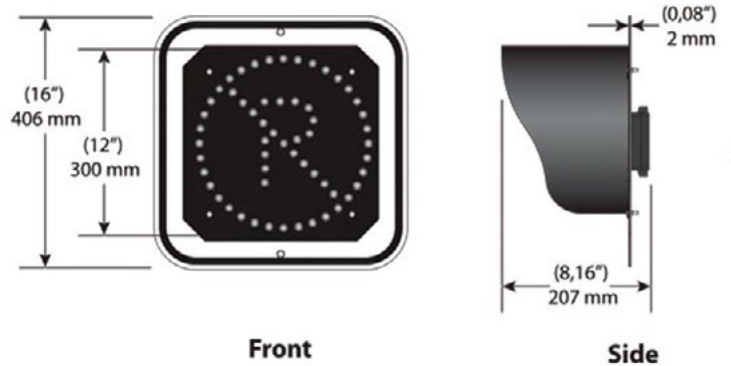

THIN LED Parking Management Sign

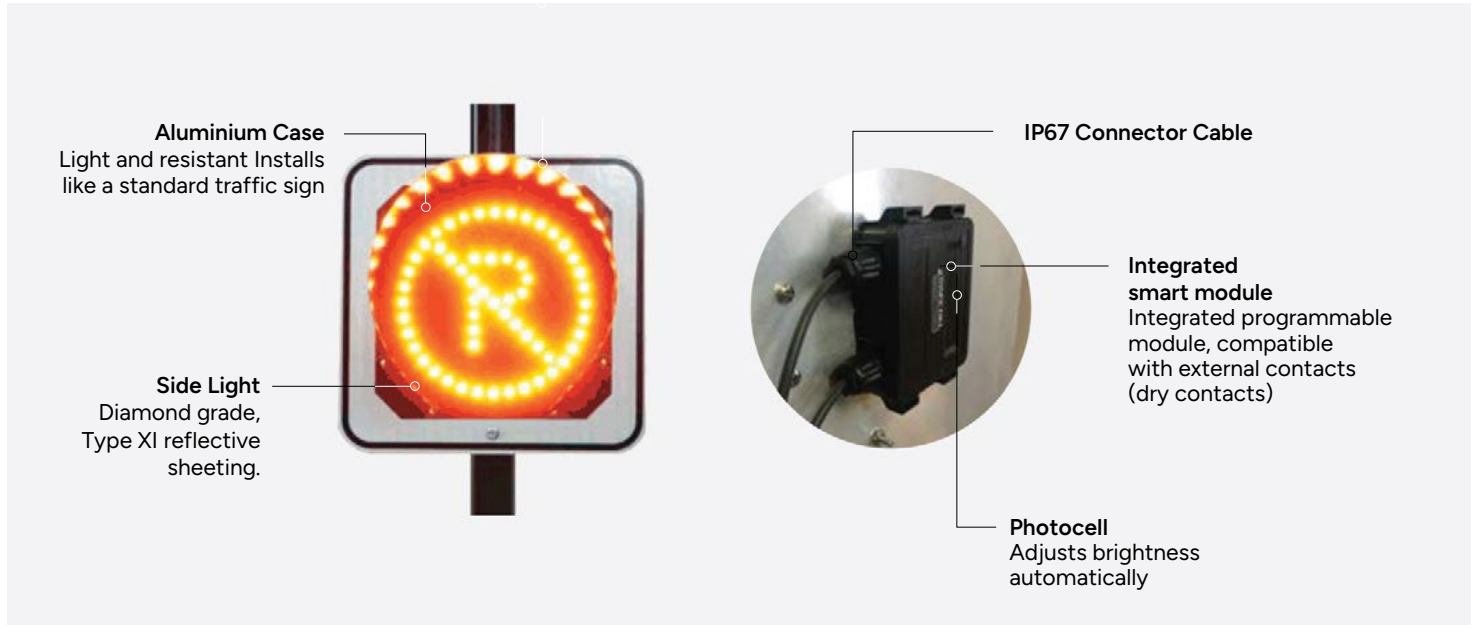







Solar Power Unit (All-in-one)



THIN LED Parking Management Sign



Product	Box Size - Weight	HSS Code
  <p>Assembly Kit # 38267 12 x 12" 'No Parking' LED Flashing Beacon 8" (200mm) 30W Solar Power Unit</p>	18 x 32 x 14 in - 36 lb	8530.90
  <p>Assembly Kit # 38267 16 x 16" 'No Parking' LED Flashing Beacon 12" (300mm) 30W Solar Power Unit</p>	18 x 32 x 14 in - 36 lb	8530.90
 <p>Assembly Kit # 38267 12 x 12" 'No Parking' LED Flashing Beacon 8" (200mm) - AC/DC Converter</p>	18 x 32 x 14 in - 36 lb	8530.90
 <p>Assembly Kit # 38267 16 x 16" 'No Parking' LED Flashing Beacon 12" (300mm) - AC/DC Converter</p>	18 x 32 x 14 in - 36 lb	8530.90

Activation Options

 <p>Activation Option # 36463 Wireless and battery free Remote Control</p>	Included in kit box	N/A
---	---------------------	-----

Included with Assembly Kit : Installation hardware for 2" Telespar post, 2-3/8" round pole, U-Post or streetlight pole. Two (2) years Limited Warranty against defects in workmanship and materials.

Wireless and without battery

Remote Control

Our Remote control is a wireless and battery-less remote controller. The mechanical energy created by pushing the button(s) is transformed, via a revolutionary magneto-resistive generator, in enough electrical energy to send a radio frame to the controlled device. The Remote Control allows control of any kind of Traffic LED device.

Spill and shock resistant, the Remote Control can be used anywhere. Its heavy-duty clip allows to fix it on a belt or on the truck sun visor. Requires transceiver # 36262.

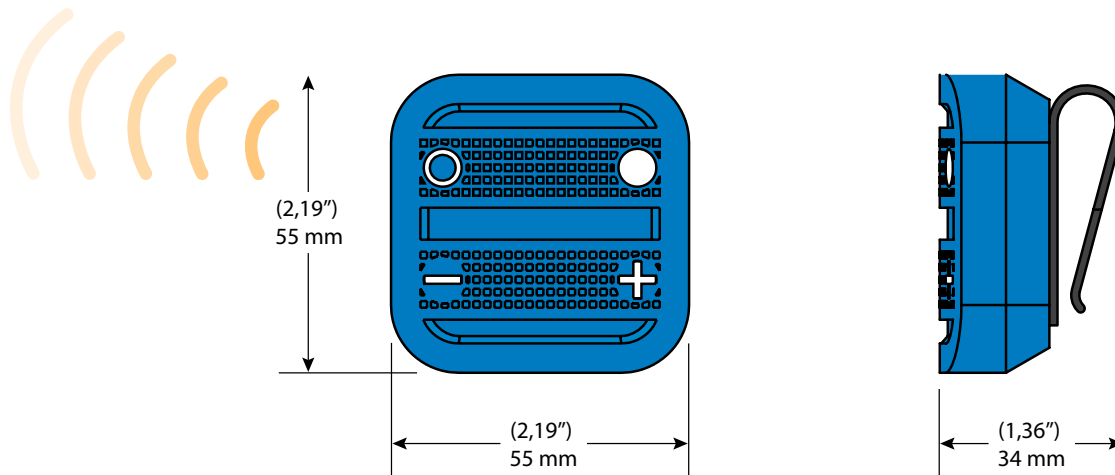

Warranty : 2 year Limited Warranty for defects in workmanship and materials

Electrical component		Material	
Buttons Control	Start and Stop LED sign	Housing	Silicone Blue
Energy Source	Motion generator (no battery)	Belt Clip	Polycarbonate
Wireless Communication	Encrypted message, 902 MHz band, low power	Environmental protection	IP54
Transmission Range	up to 100 m free field	Weight	0,5 lbs (0,2 kg)
Operating temperature	-40°F to + 165°F (-40°C to +74°C)	Shipping	

Box Size	305 x 203 x 75 mm (12 x 8 x 3")
Weight	2 lbs (0,9kg)

Required
Receiver/Transceiver
for LED sign #36262



THIN Dynamic LED Street Parking Management

- Snow Removal
- Street Sweeping
- Street Work
- Events
- Neighborhood Festivals

The THIN Dynamic LED Parking Sign is designed for seasonal and winter parking management. Thanks to wireless communication and activation, your managers will be able to effectively manage signage, greatly facilitating maintenance operations.

This dynamic communication mode significantly enhances the clarity and simplicity of the message, resulting in a positive response from citizens. This INNOVATIVE technology significantly reduces the time required for maintenance through real-time information broadcasting.

Solar Power Supply



Easy Installation on standard posts



Wireless activation



Increases Driver Awareness



THIN Dynamic LED Street Parking Management

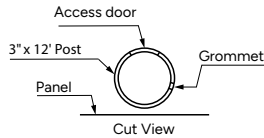

Dynamic no parking signs with VMS
 - LED no parking sign "
 - Variable message sign

Solar panel 80W All-In-One
 including 40Ah LiFePO4
 battery and MPPT charger
 (south-oriented)

Solar panel support
 fixed with 2 sets of 3
 stainless steel countersunk
 pressure screws

Access door
 and cable gland
 with grommet

Static panel P-150-8
 Standard Sign

Round pole 3"
 (schedule 40) x 12'
 Zinc Galvanise
 or galvanise and painted
 powder coat, if post
 is required.

Ground Anchor Sleeve 900 mm
 Galvanized steel
 By Traffic Innovation

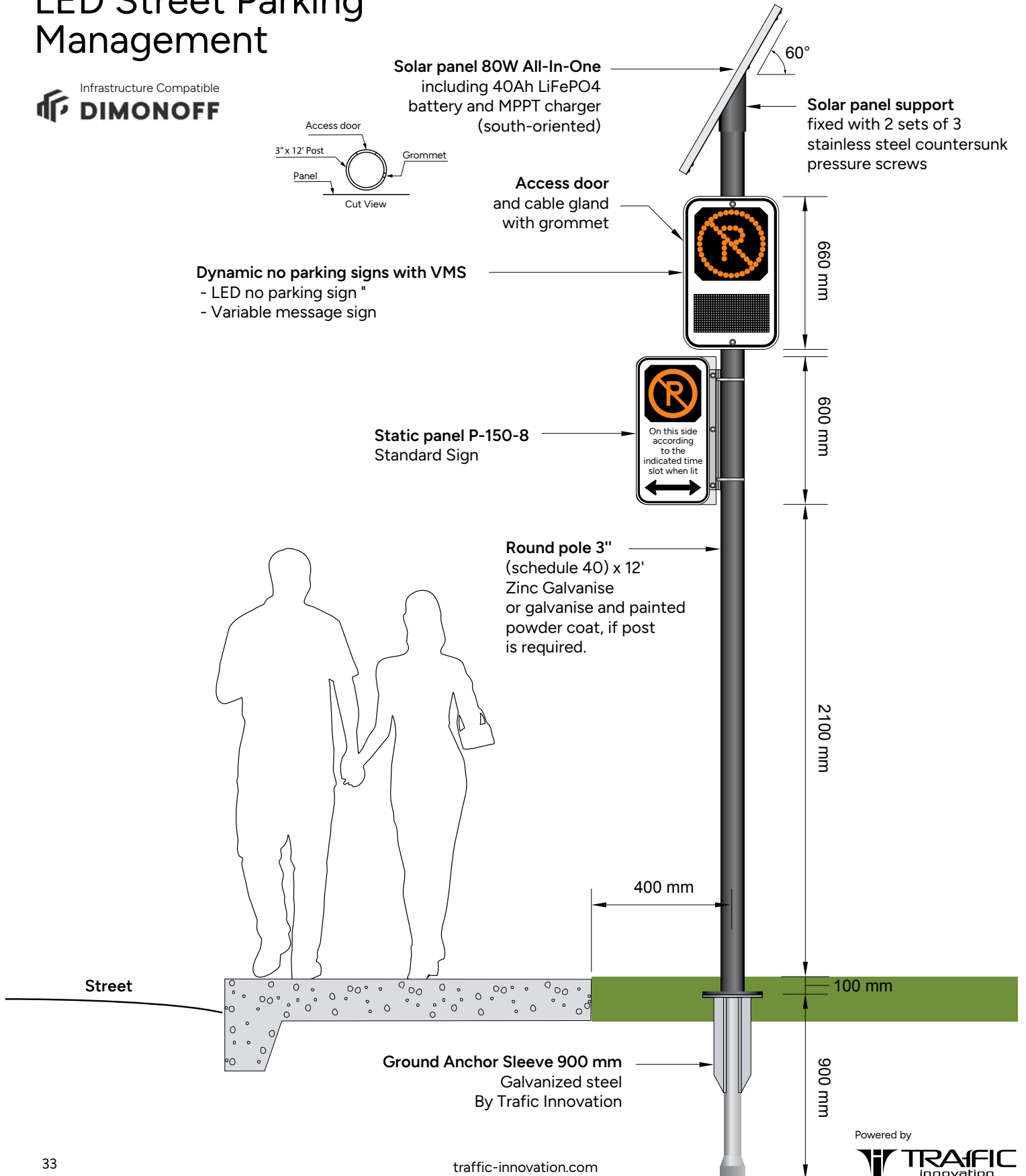

THIN-12 Radar Speed Feedback Sign

The THIN-12 speed display sign is a very effective traffic calming device. It is the first patented thin speed display in the world. It is as light and thin as a standard traffic sign (3.25 mm, 0.125" thick) which allows it to be installed on any signpost and thus save on installation costs.

The radar also serves as a traffic analyzer and can classify four different types of vehicles by speed and period.

Educational Tool



Reduces Speed by up to 30%



Data Collector



Increase Safety



THIN-12 Radar Speed Feedback Sign

2⁺
years warranty

Radar Driver Feedback Sign

Radar	Doppler
Range	Between 50 m (164") and 300 m (1000")
Width	12°H x 24°V
Data Acquisition	Bidirectional
Precision	± 1 km/h (0.6 mph)
Wireless communication Bluetooth	(optional), 50 m (160") range
Display Size	330 x 521 mm (13" x 20.5")
Digit Height	305 mm (12 1/8") – 202 LEDs
LED Angularity	30°
Color of LED	Amber
Visibility	More than 300 m (1000")
Auto-Dimming	Variable based on ambient light
Voltage In	10.8 to 15 VDC
Max Power Consumption	36 W
Strobe Color (optional)	White
Snap-in Connector	10 mm OD, Male, 6", IP67
Back Plate	Aluminum 3 mm (0.125") 5052H38
Sign Face (Yellow or White)	Type III reflective sheeting
Sign Face (Orange or Green)	Type XI reflective sheeting
Shield Protection	5 mm (0.188") polycarbonate (Black)
Waterproof Rating	IP65
Operational Temperature	-40 to +65°C (-40 to +149°F)
Monocrystalline Cells	Higher efficiency solar panel to optimise size
Lithium Lifepo4 battery	Light and slim 10 years life expectancies Maintenance free
MPPT Charger	Increases charging efficiency by minimum 20% compare to PWM

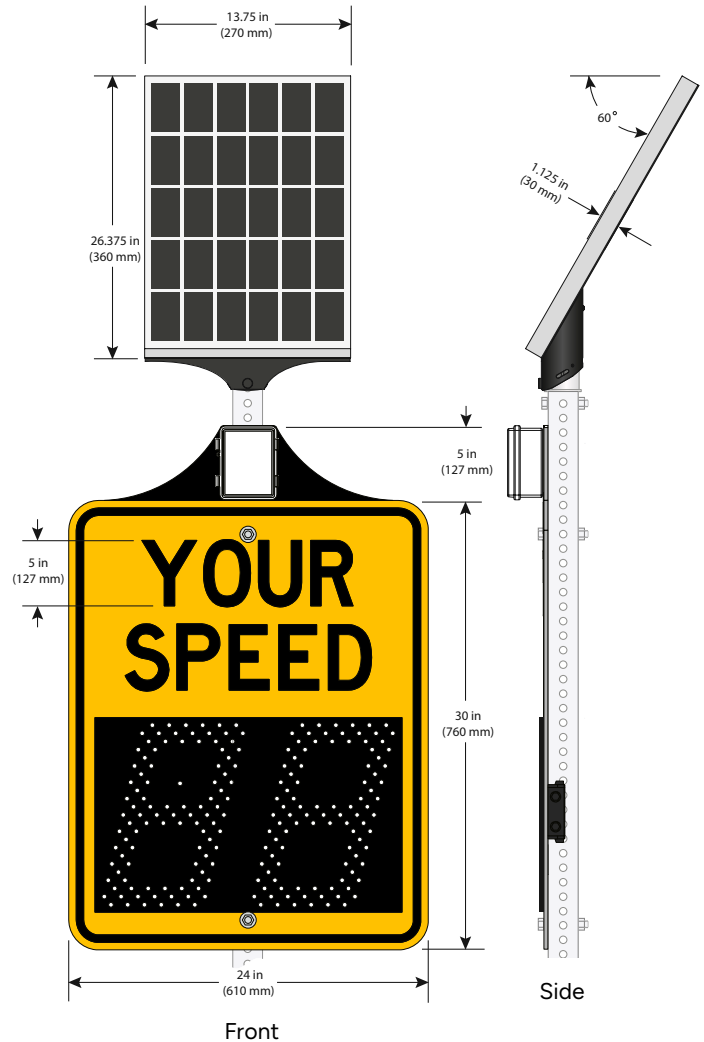

Radar Programming

The radar is equipped with a programming menu that allows you to configure the speed display no computer needed.

Micro SD Card

Radar

Security Screw

Programming Menu

On / Off Switch

Amber Light = Operation

Blue Light = Radar Operating

Green Light = VCC Internal Battery Satus

Control buttons

- Select Menu / Confirm Selection
- Cancel Selection / Previous Menu
- Navigate Left - Right Cycle Selction Cycle Options

When a flasher is added to the THIN-12, the flasher will turn ON for speeds above this treshold. Flasher is added as an option. To enter the menu, press 2x on the blue button.

Basic Programming

	Limit	25mph
	Max Speed	25 + 19 mph
	Blink Speed	6mph (Speed at which blinking starts)
	Bright Min	10%
	Bright Max	100%
	Speed-From	6,2mph
	Speed-To	75 mph
	Bin-Width	5
	Period:	15
	Targets Log	ON
	Speed Bins	Enabled
	Power Log	Enabled
	Sys Time	Allows to set time
	Sys Date	Allows to set date
	Strobe-On	40mph*
	Strobe-Off	56mph*

Basic Programming

	Speed Unites	mph
	Demo Mode	OFF
	Disp Traffic	Inbound
	Disp Select	Closest
	Sleep Cycle	0
	Lowest Speed	(8mph)
	RSSI Filter	30
	RSSI Delta	400
	Speed Delta	12 samples
	Stat Confirm	5 samples
	Signal Lost	2 samples
	Targ. Confirm	x1
	Amp. Factor	



Standard MUTCD lettering that can be used on any type of road. Adding a legal speed limit sign is recommended.



Compact Lettering that does not require the addition of a speed limit sign. Come with all speed numbers decal : 1234567890



#38046



#38179



#38052



#38055



#33333



















#33333



#33333



#33333

Product	Box Size - Weight	HSS Code
  Assembly Kit #38046 White background, Radar Driver Feedback Speed Sign, 30W Solar Power Unit	32 x 40 x 8 in - 30 lb	8530.90
  Assembly Kit #38179 Yellow background, Radar Driver Feedback Speed Sign, 30W Solar Power Unit	32 x 40 x 8 in - 30 lb	8530.90
  Assembly Kit #38052 Yellow / Green background, Radar Driver Feedback Speed Sign, 30W Solar Power Unit	32 x 40 x 8 in - 30 lb	8530.90
  Assembly Kit #38055 Orange background, Radar Driver Feedback Speed Sign, 30W Solar Power Unit	32 x 40 x 8 in - 30 lb	8530.90
  Assembly Kit #33333 White background, Radar Driver Feedback Speed Sign, 30W Solar Power Unit	32 x 40 x 8 in - 30 lb	8530.90
  Assembly Kit #33333 Yellow background, Radar Driver Feedback Speed Sign, 30W Solar Power Unit	32 x 40 x 8 in - 30 lb	8530.90
  Assembly Kit #33333 Yellow / Green background, Radar Driver Feedback Speed Sign, 30W Solar Power Unit	32 x 40 x 8 in - 30 lb	8530.90
  Assembly Kit #33333 Orange background, Radar Driver Feedback Speed Sign, 30W Solar Power Unit	32 x 40 x 8 in - 30 lb	8530.90

Included with Assembly Kit: Installation hardware for 2" Telespar post, 2-3/8" round pole, U-Post or streetlight pole. Two (2) years Limited Warranty against defects in workmanship and materials.

THIN-12 Dolly Portable Radar Speed Feedback Sign

The THIN-12 Dolly portable speed display is a small wheeled trolley equipped with a battery and a speed display.

It can be used for school zone industrial and commercial area to slow down traffic. The THIN-Dolly 12 is extremely easy to use.

Educational
Tool

Reduces Speed
by up to 30%

Easy Solo
Handling

Increase
Safety

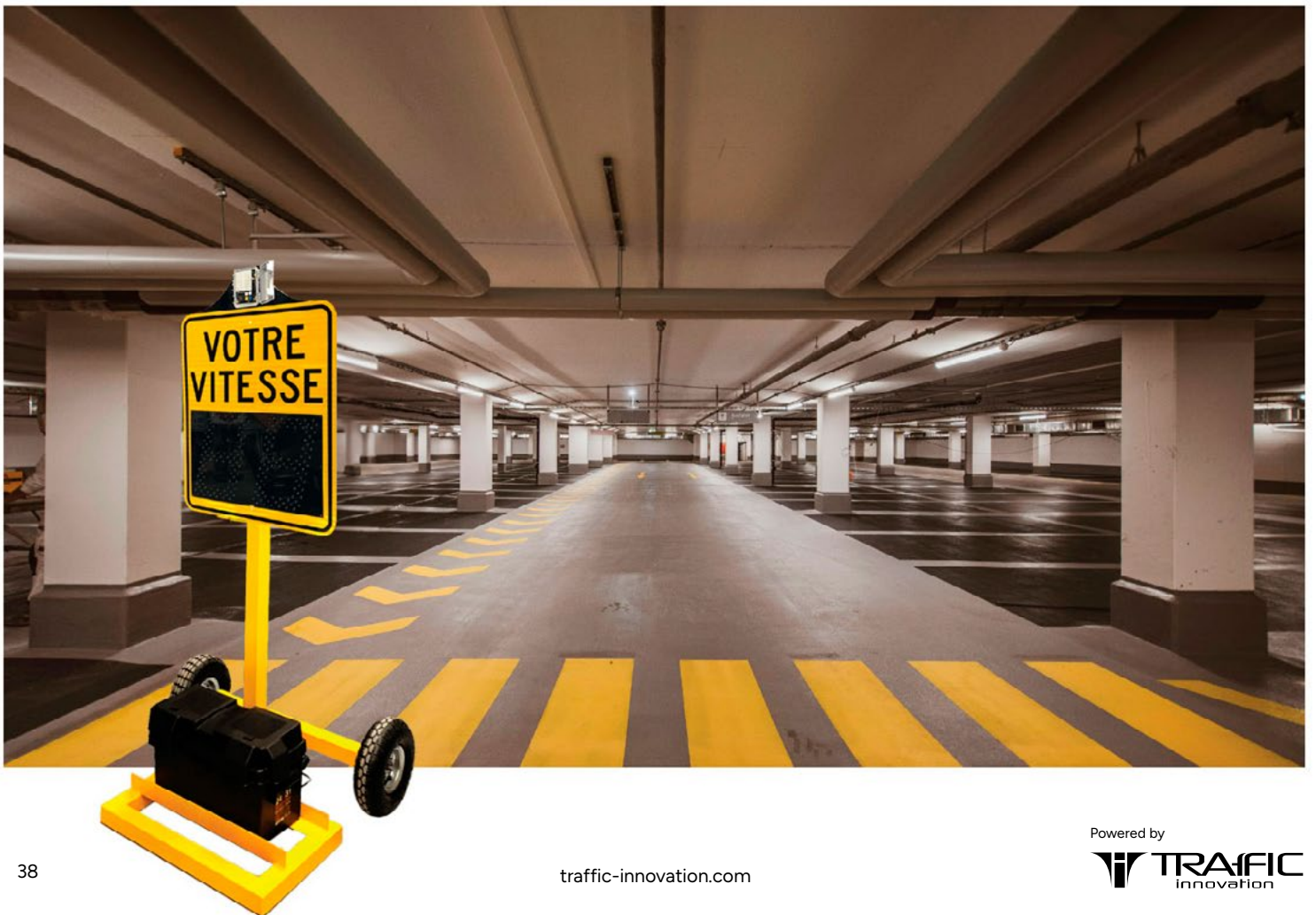

THIN-12 Dolly Portable Radar Speed Feedback Sign

2⁺
years
warranty

Materials

Battery housing	Black Polyethylene (PEHD)
Structure	Painted steel powder coated polyester
Structure Color	Yellow RAL 1003
Wheels	Pneumatic 254 mm (10")
Hardware	Stainless Steel
Weight	72 lb (33 kg)

Electrical Components (Optional)

Battery	AGM 12V - 110 Ah
Display	THIN-12C
Wall charger	3.5 Amp
Operational temp.	-40 to +65°C (-40 to +149°F)

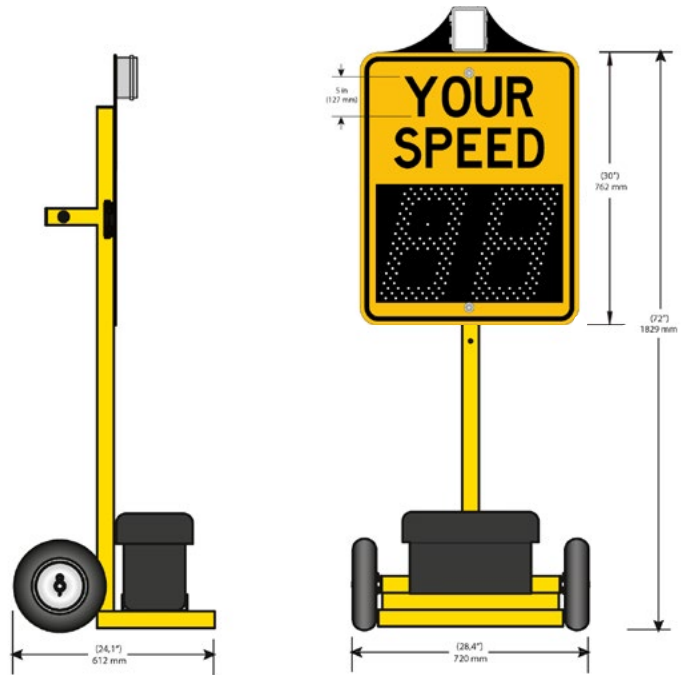

Product	Box Size - Weight	HSS Code
 Assembly Kit # 373399 Dolly Mobile Driver Feedback Sign - THIN 12	32 x 32 x 8 in - 15 lb	8530.90
Battery Option		
Battery Option # 36431 AGM 12V 110 Ah Battery (One)	8 x 16 x 12 in - 50 lb	N/A

Included with Assembly Kit : Installation hardware for 2" Telespar post, 2-3/8" round pole, U-Post or streetlight pole. Two (2) years Limited Warranty against defects in workmanship and materials.

THIN Portable Radar Feedback Sign

During your speed awareness campaigns, the THIN Portable Speed Display is a powerful, fast-deployable tool that positively influences driver behavior. Its full-matrix display provides maximum visibility and pedagogical interaction to enforce the speed limit.

In addition, the speed display can be used in information display mode, while still performing radar detection.

Increases Driver Awareness



Data Collector



Pictograms and custom text



Increase Safety



THIN Portable Radar Feedback Sign



Electrical Components - Speed Display

Solar Panel	100 Watts - monocrystallin
Battery	12.8V - 40Ah - LifePo4
Solar Charger	MPPT, 10 A, IP67
Radar	Doppler
Range	Between 164' (50 m) and 1000' (300m)
Radar Angularity	12°H x 24°V
Data Acquisition	Bidirectional
Precision	+/- 1 Km/h
Wireless Communication	Bluetooth, Range 160' (50m)
Screen Format	13 x 20.5" (330 x 521mm)
Digit Height	12" (305mm) - 202 LEDs
LED Angularity	30 degrees
LED Color	Amber
Visibility	Over 1000' (300m)
Photocell	Varies depending on ambient lighting
Input Voltage	10.8 to 15 VDC
Max Power Consumption	36 Watts
Connector	10mm OD, Male, 6 inches, IP67
Panel	Aluminum 0.125" (3mm) 5052H38
Film Panel (Yellow or White)	Reflective Type III
Protective Film	Polycarbonate black 0.188" (5mm)
Seal	IP65
Operating Temperature	-40 to +149°F (-40 to +65°C)

Trailer

Equipment	Galvanized steel
Finish	Flat grey paint
Axles	Independent half-axles, 1400 lb
Lights	LED
Connection	7-way round pin
Wheels	18 inches
Total weight (including display)	650 lb (295 kg)

Pole (trailer mast)

Size	102 mm (4") diameter
Material	Galvanized steel
Finish	Textured black paint

Electrical Components - Radar

Range	300 m (1000') adjustable
Angularity	12°H x 24°V
Programming	Speed threshold and pictogram
Programming Method	Manually on-site
Data Acquisition	Unidirectional (software included)
Precision	+/- 1 Km/H
Wireless Communication	Bluetooth, range of 50 m (160')

Product		Box Size - Weight	HSS Code
	THIN - 12- REM Portable Speed Display with solar panel and battery (1)	Skid 42 x 48 x 80 in - 800LB	8530.90

Included with Assembly Kit: Two (2) years Limited Warranty against defects in workmanship and materials.

THIN SSA-3 Portable Radar Speed Feedback and Message Sign

During your speed awareness campaigns, the THIN SSA-3 Portable Speed Display is a powerful, fast-deployable tool that positively influences driver behavior. Its full-matrix display provides maximum visibility and pedagogical interaction to enforce the speed limit.

In addition, the speed display can be used in information display mode, while still performing radar detection.

Increases Driver Awareness



Data Collector



Pictograms and custom text



Increase Safety

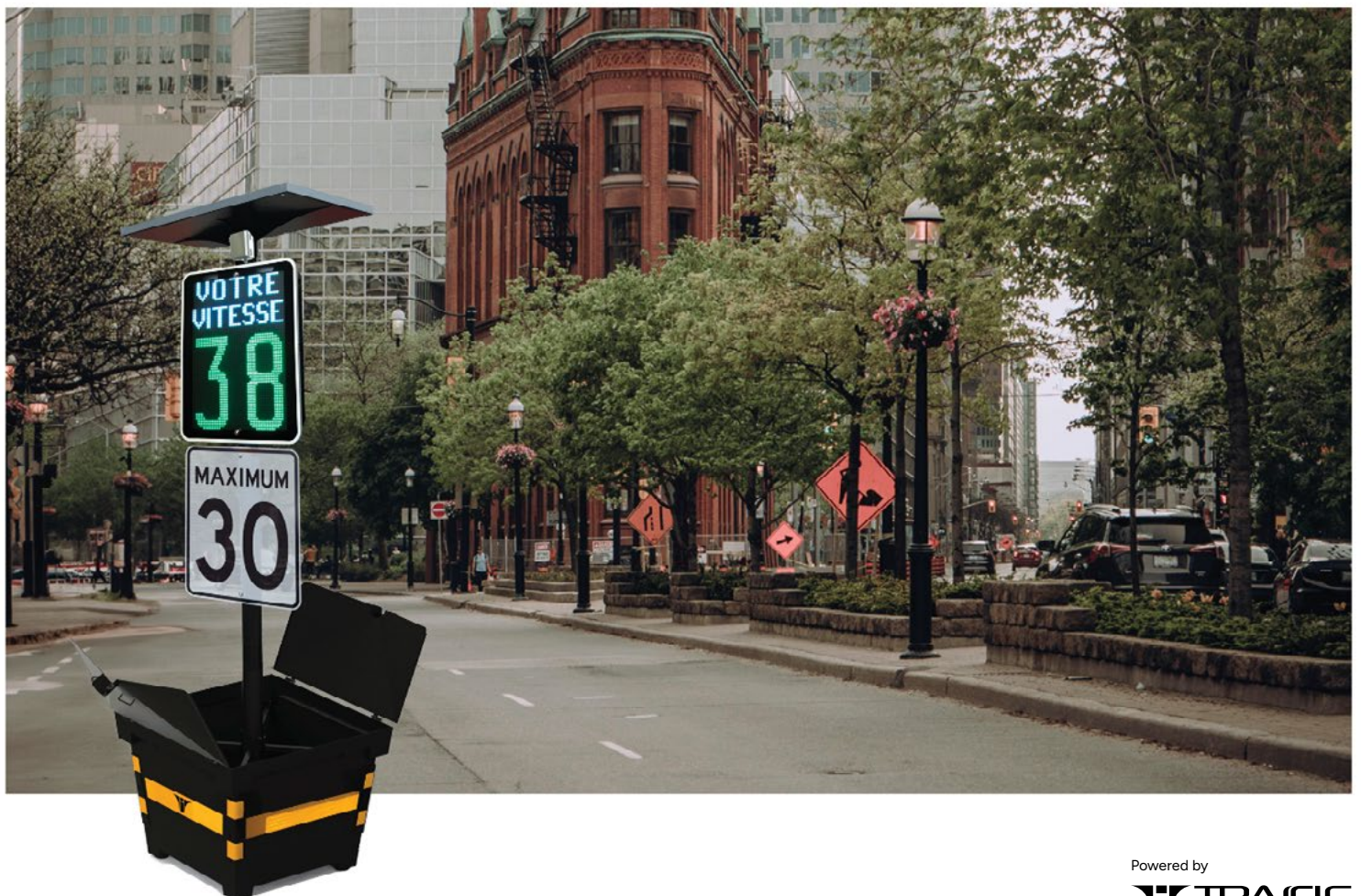

THIN SSA-3 Portable Radar Speed Feedback and Message Sign

Structure

Design	Designed for use with the RSSA trailer.
Materials	Galvanized steel, painted with textured black polyester powder.
Interior	Secured by two hinged doors and an anti-theft system for the battery, charger, wall socket system, charge indicator, switch and storage space for 6 to 8 signs, depending on awareness needs.
Protection	The case is also equipped with 4 type-4 reflective strips and rubber protective corners.
Stability	The device's weight of 700 lb (320 kg) and its 39"/990 mm wheelbase have been calculated to minimize its imprint on the road and maximize its anti-rollover property.
Pole	The steel pole rotates 360°, which makes it possible to angle the display towards traffic or keep it parallel to the structure during transport. The surface of the pole has perforations designed specifically for the speed display and prescription sign.

SSA-3 with Battery

Model	Kamelion-15
Housing	Polyethylene (HDPE) with UV protection
Sign face	5 mm (.188") polycarbonate with antiglare
Environmental Protection	IP65
Weight	700 lbs (330 kg)
Standard	ATC
Screen format	640 x 480 mm (25 x 19")
Resolution	64 x 48 pixels
Angularity	50° x 100°
Visibility	300 m (1000')
Colors	RGB (red, blue, green) 7 colors

SSA-3 with Battery

Text	Messages and pictograms are tricolor according to the speed limit displayed
Max Power Consumption	180 Wh
Voltage in	10,8 to 15 VDC
Connector	Snap-in, overmolded IP67, 10 mm OD
Communication	Bluetooth, 50m (160') range
Strobes	18 Watts ambers
Photocell	Variable according ambient light
Text	Up to 8 lines of 12 characters of 70 mm (2 3/4")
Operating temperature	-40 à +65°C (-40 à +149°F)

Visibility

A long reading time will have a positive impact on road user behavior. The higher the speed limit, the higher the height of the numbers should be so that drivers have the time to read messages and adjust their speeds.

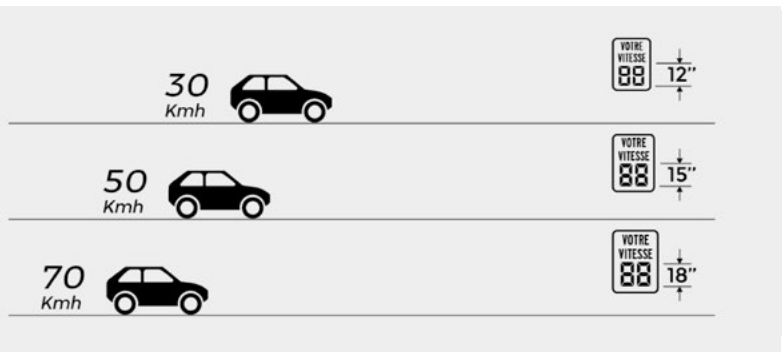

Powered by



THIN SSA-3 Portable Radar Speed Feedback and Message Sign

The KAM-15 is a 7-color, full-matrix speed display sign. With its 640 x 480 mm screen, it is possible to display digits with a height of 380 mm (15" while leaving enough space for a text box. The specially designed educational radar allows the configuration of the speed display sign. More than 10 pre-programmed pictograms (kam-Smart) are available depending on the displayed speed.

In addition, the radar allows data collection and RRFB activation for excessive speeds. To prevent the speed display from becoming part of the urban environment and losing its positive influence, the Kamelion-15 can be transformed. In a programmable time slot, the kam-Smart (Educational Speed display) speed display function can become a KAM-Sens (road awareness) or a KAM-Sign Temporary signage.



KAM-SMART Educational Speed Display

The KAM-SMART function makes configuration fast and easy. A digital screen is integrated into the radar, so the user can select speed ranges, pictograms, data collection and strobe activation. The pictograms and color speed display create an educational interaction with the road user. Turning on a speed display has never been easier. If necessary, the KAM-TOOL software allows you to customize the pictograms and define the speed ranges according to a schedule.



KAM-SENS Road awareness

The KAM-SENS function is included with the KAM-15 device. With this function, the device can relay awareness campaigns on various road safety issues. An internal calendar allows you to choose messages according to the time of day or week. This function makes it possible to alternate the use of the KAM-15 between the speed display mode and the awareness campaign mode, which catches the attention of road users.



KAM-SIGN Temporary signage

The KAM-SIGN function is included with the KAM-15 device. With this function, the device can report an unforeseen event that needs to be communicated to road users. Using the Matrix Image Editor software, which comes free of charge with the Kamelion, it is possible to create personalized messages and transfer them to the KAM-15 via Bluetooth. A Kamelion, installed on a transportable unit, will thus be able to perform the same functions as a variable message sign on a trailer.



Powered by



THIN SSA-3 Portable Radar Speed Feedback and Message Sign

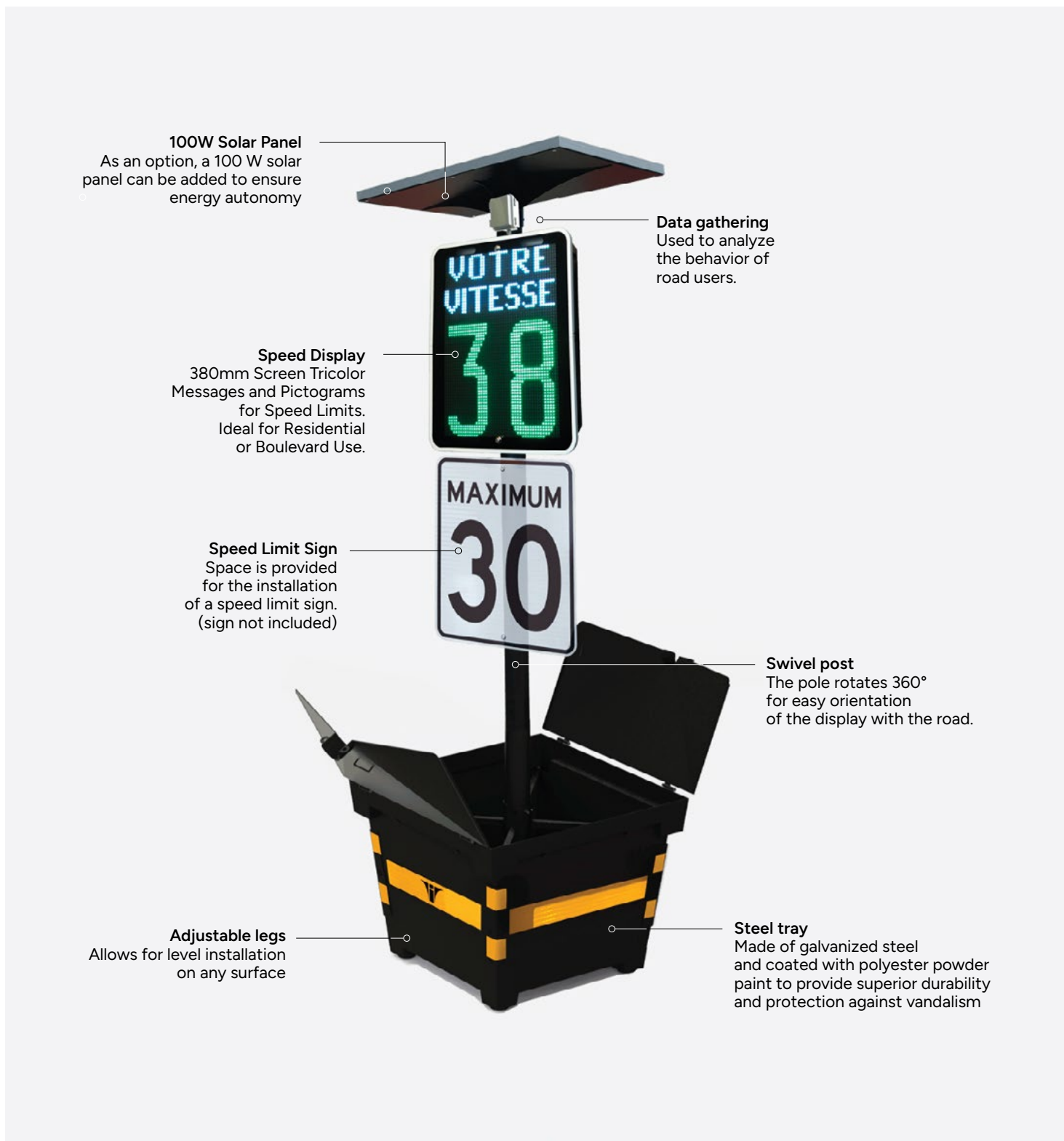

THIN SSA-3 Portable Radar Speed Feedback and Message Sign

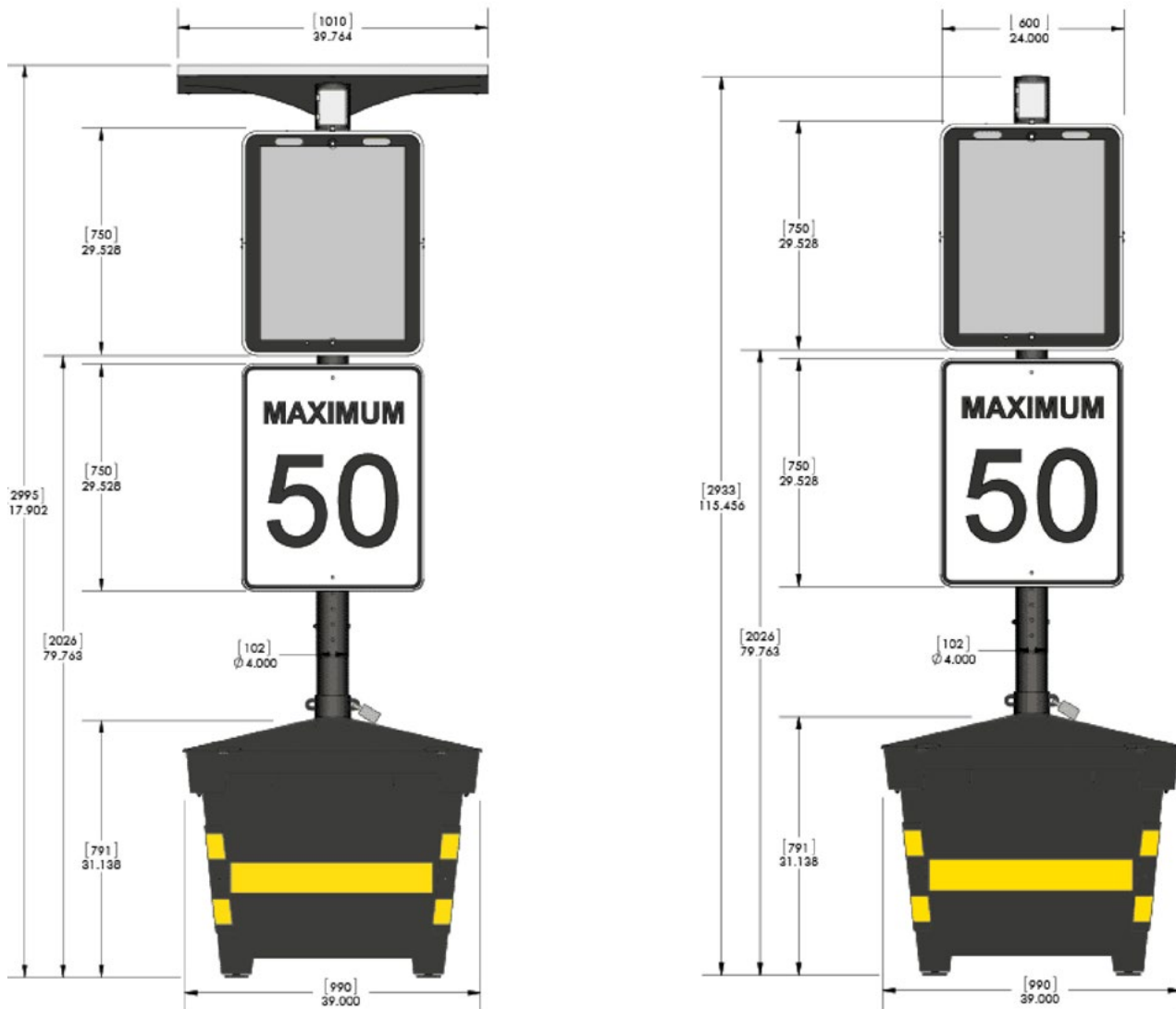

SSA-3 with Solar Panel

Battery	AGM 110 Ah
120V Wall Charger	10 Amp, Noco Genius10
Solar Panel	100 W monocrystallin constantly recharges the battery.
Solar Charger	MPPT, 10 Amperes
Autonomy	about 5 days without sunlight

SSA-3 with Battery

Battery	4x 110 Ah (440 Ah) AGM batteries
Autonomy	3-to-4-week
120V Wall charger	25 Amp, Noco GeniusPro25 for overnight batteries recharge

SSA-3 Trailer

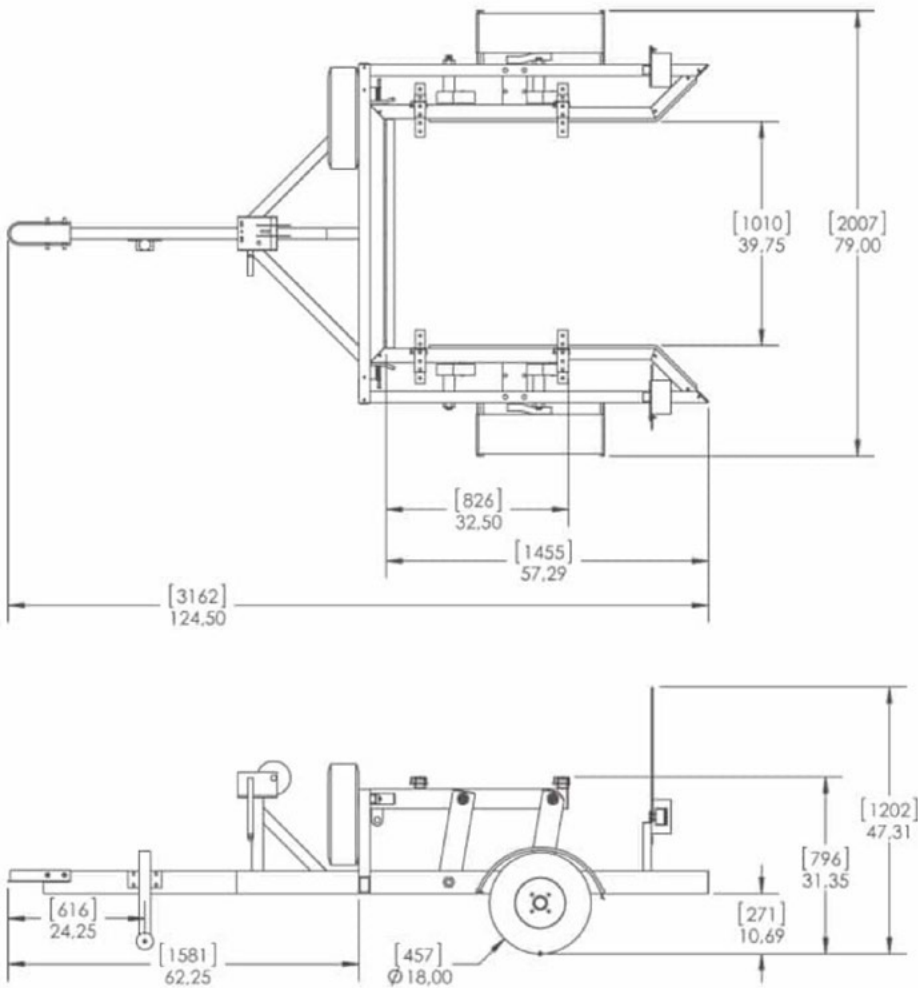



SSA-3 Trailer

Material	Galvanized Steel
Features	Jack, Winch, Spare Wheel 457 mm(18')
Lights	LED
Suspension	Independent Wheel
Coupler	50 mm (2")

SSA-3 Trailer Dimensions

Length Overall	3162 mm (124.5")
Width, Overall	2007 mm (79")
Width, Useful	1010 mm (39.75")
Ground Clearance	267 mm (10.5")
Weight	275 kg (606 lb)

THIN SSA-3 Portable Radar Speed Feedback and Message Sign

Product	Box Size - Weight	HSS Code
 <p>Assembly Kit # 38500 SSA-3 Portable Speed Display with 380 Ah batteries (1)</p>	<p>Skid 42 x 48 x 80 in - 800LB</p>	<p>8530.90</p>
 <p>Assembly Kit # 38593 SSA-3 Portable Speed Display with solar panel & 100Ah battery (1)</p>	<p>Skid 42 x 48 x 80 in - 800LB</p>	<p>8530.90</p>
<p>Included with Assembly Kit: Two (2) years Limited Warranty against defects in workmanship and materials.</p>		
<p>:</p>		
<p>Option</p>	<p>.</p>	
 <p>RSSA-3 Trailer Trailer</p>	<p>N/A</p>	<p>N/A</p>



✓ Patented Technology

THIN Lightweight LED Traffic signs

The ULTRA-THIN electronic LED traffic sign was built using a patented assembly method that allows all electronic components to be incorporated into the thickness of a standard traffic sign. Covered with reflective film, it is as light as a standard sign in addition to meeting the IP67 waterproofing standard, including protection against dust and water. The sign can easily be installed on any type of pole or signal structure.

In combination with the Traffic Solar Unit, it is one of the most economical systems for transforming a standard road sign into an intelligent electronic sign.

Discrete, light and thin design



Low cost and easy Installation



Patented Technology



Weather Resistant



Most common LED Signage Installation



Our Thin LED Sign System



✓ Patented Technology

THIN Lightweight LED Traffic signs



THIN LED Stop Sign

Our luminous LED stop sign is advantageous in terms of quality and visibility. The bright outline of the stop sign encourages drivers to stop.



Thin Simple Amber or Red Flashing Beacon

The 8" smart flashing beacon is an electronic LED sign made to reinforce signaling in critical areas, such as school zones and crosswalks.



Thin Small Dual Flashing Beacon

With its high intensity LEDs, the 8" smart dual flashing beacon for school zone provides a clear indication of zone change and enhances security.



Thin Dual Flashing Beacon Sign

The 8" smart dual flashing beacon sign flashes alternately to attract the drivers' attention and reinforce a message.



Thin Led Parking Sign

Visible and adapted to winter conditions, our P-150-8 winter LED parking sign allows you to better manage traffic.



Thin-12 Radar Speed Feedback Sign

Our THIN-12 radar driver feedback sign is the first of its kind. Lightweight and visible, its thin design makes it easy to install.

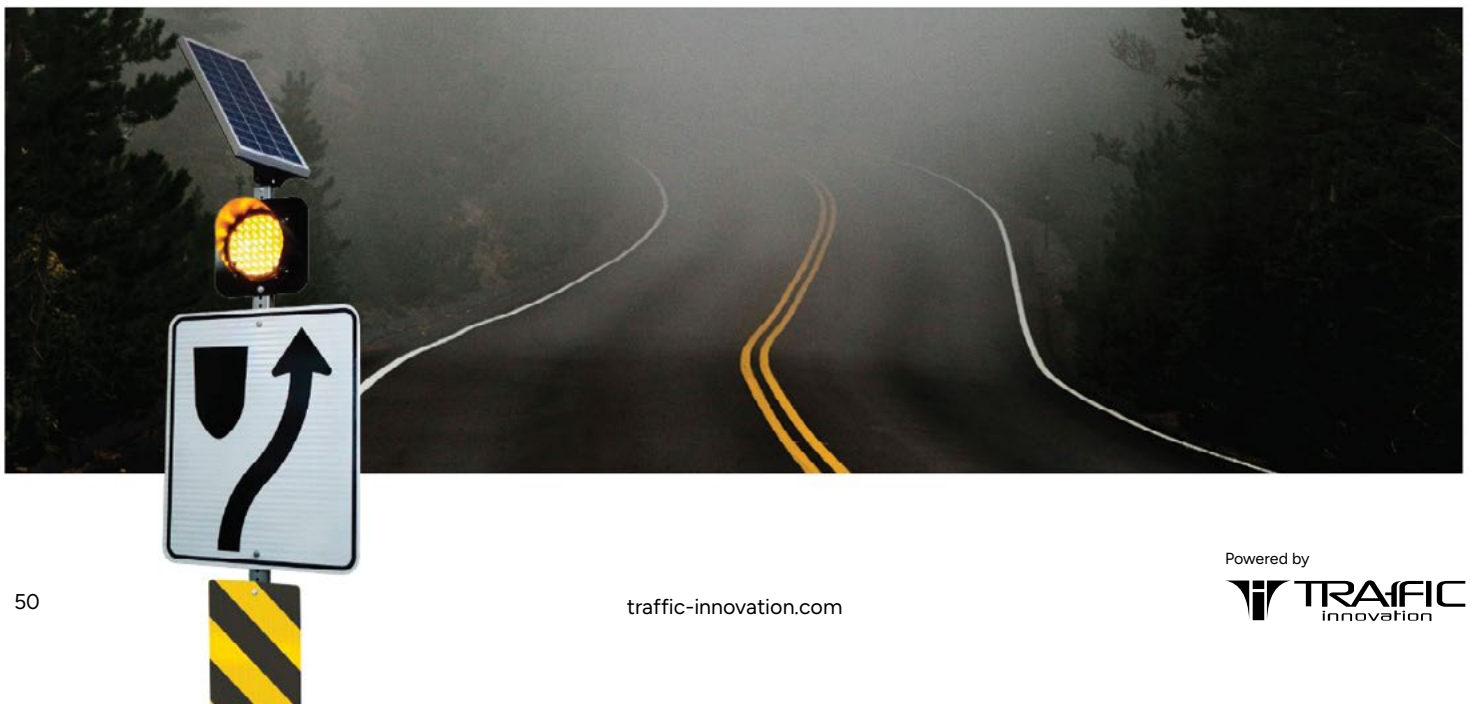

✓ Patented Technology

Solar Power Unit All-In-One

Lightweight and easy to install, it quickly connects to any of our ULTRA-THIN signs. This product has been developed specifically for road applications. It is compatible with most roadside traffic posts and meets all requirements specific to road products. Designed to operate year-round.

- Photovoltaic with sensor with in an aluminum enclosure
- Operating Temperature: -40 to +165°F (-40 to +74°C)
- Enclosure plate
- Long lasting LifePO4 lithium battery
- Smart MPPT charger to maximize charging
- Battery status LED indicator
- Universal mount for a quick setup
- IP 67 connector cable

Discrete, light and thin design



Easy Installation on standard posts



Years Life Expectancy



Green Energy



Solar Power Unit (All-in-one)

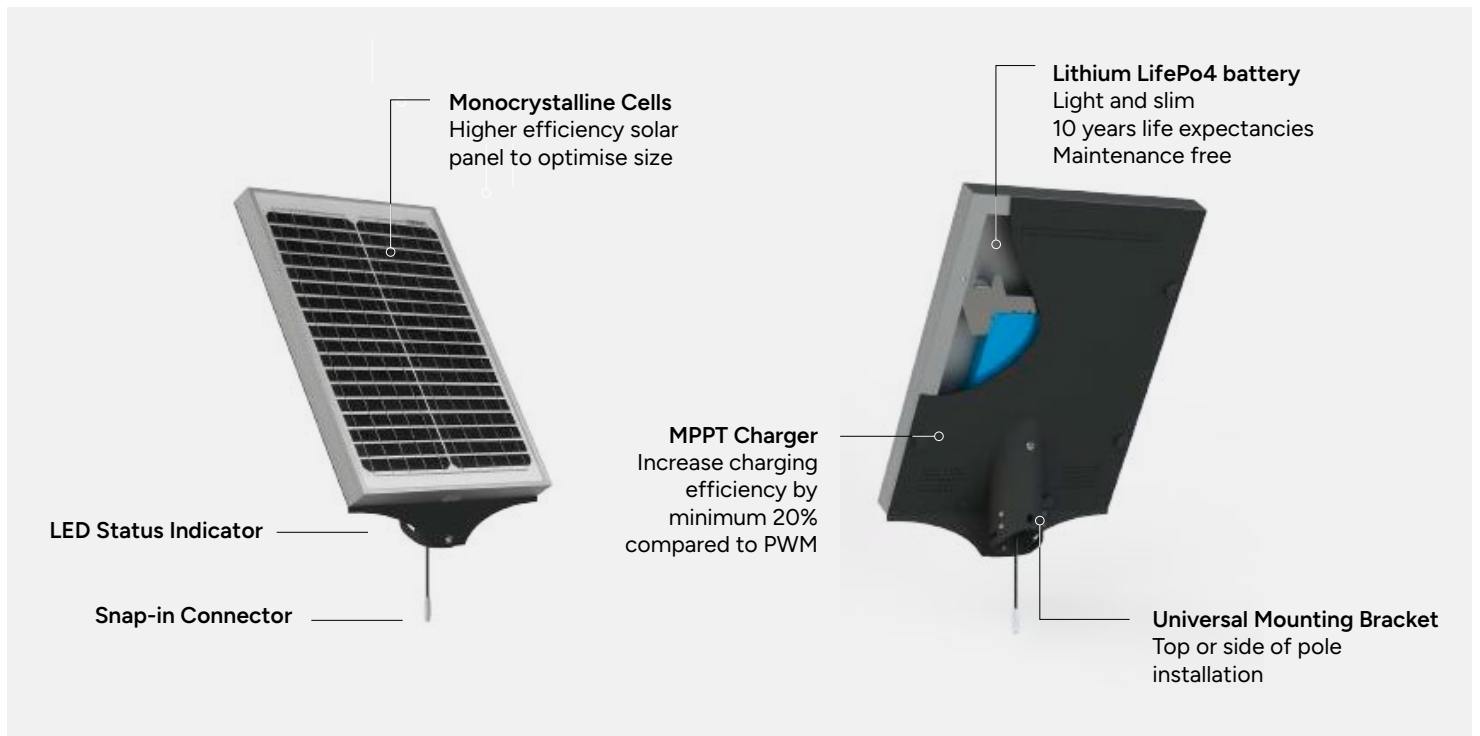



Solar Power Unit All-In-One

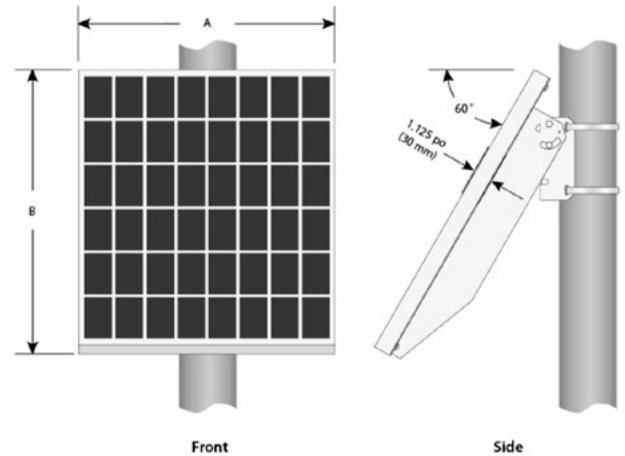
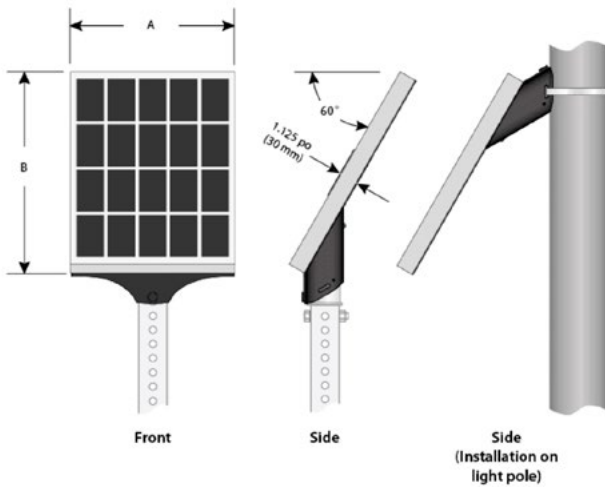

Solar Power Unit (10 w)

Solar Panel	10 W – monocrystalline
Battery	12.8 V – 9 Ah – LifePo4
Solar Charger	MPPT, 10 A, IP67
Connector	10 mm OD, male, 6", IP67
Operating Temperature	-40 to +165°F (-40 to +74°C)
Weight	4.5 kg (10 lb)
Width	(A): 270 mm (10.63")
Height	(B): 360 mm (14.17")

Solar Power Unit (50 w)

Solar Panel	50 W – monocrystalline
Battery	12.8 V – 27 Ah – LifePo4
Solar Charger	MPPT, 10 A, IP67
Connector	10 mm OD, male, 6", IP67
Operating Temperature	-40 to +165°F (-40 to +74°C)
Weight	11 kg (24 lb)
Width	(A): 537 mm (21.13")
Height	(B): 670 mm (26.38")

Solar Power Unit (30 w)

Solar Panel	30 W – monocrystalline
Battery	12.8 V – 14 Ah – LifePo4
Solar Charger	MPPT, 10 A, IP67
Connector	10 mm OD, male, 6", IP67
Operating Temperature	-40 to +165°F (-40 to +74°C)
Weight	7.7 kg (17 lb)
Width	(A): 350 mm (13.80")
Height	(B): 670 mm (26.38")





Solar Power Unit (100 w)









Solar Panel	100 W – monocrystalline
Battery	12.8 V – 40 Ah – LifePo4
Solar Charger	MPPT, 10 A, IP67
Connector	10 mm OD, male, 6", IP67
Operating Temperature	-40 to +165°F (-40 to +74°C)
Weight	16 kg (36 lb)
Width	(A): 537 mm (21.13")
Height	(B): 1010 mm (39.75")



Solar Power Unit All-In-One



Products		Box Size - Weight	HSS Code
	Assembly Kit # 36233 10 W Traffic Solar Power Unit (plug-and-play) with 9 Ah battery & MPPT charger	12 x 18 x 6 in - 14 lb	8530.80
	Assembly Kit # 35983 30 W Traffic Solar Power Unit (plug-and-play) with 14 Ah battery & MPPT charger	12 x 28 x 6 in - 21 lb	8530.80
	Assembly Kit # 35919 50 W Traffic Solar Power Unit (plug-and-play) with 27 Ah battery & MPPT charger	24 x 36 x 6 in - 29 lb	8530.80
	Assembly Kit # 38267 100 W Traffic Solar Power Unit (plug-and-play) with 40 Ah battery & MPPT charger	48 x 36 x 6 in - 45 lb	8530.80

Options			
	35910 2 m female cable (for other use)	Box + 2 lb	8530.80
	36300 3 m extension male/female	Box + 3 lb	8530.80
	500 Connector : to connect (two pins to any type of use)	Box + 3 lb	8530.80
	37072 2.5' extension cable (male/femelle)	5" x 3" x 2" 1 lb	8530.80
	37019 5' extension cable (male/femelle)	5" x 3" x 2" 1 lb	8530.80
	36300 10' extension cable (male/femelle)	5" x 3" x 2" 1 lb	8530.80
	37824 2 meters cable for other 12v power source	5" x 3" x 2" 1 lb	8530.80
	35911 60' cable with compatible Solar Unit Connector for other use	5" x 3" x 2" 1 lb	8530.80

Included with Assembly Kit : Installation hardware for 2" Telespar post, 2-3/8" round pole, U-Post or streetlight pole. Two (2) years Limited Warranty against defects in workmanship and materials.

✓ Patented Technology

Solar Power Unit All-In-One

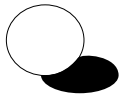

Shadow of buildings, trees or power lines on the solar panel makes energy efficiency practically zero



The solar panel must face noon sun. If the solar panel is oriented on the opposite side, energy efficiency will be zero

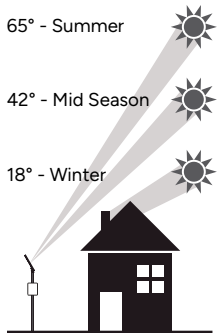

Example for 45th parallel North

During winter solstice, hours of sunshine reduced and sun will also be at its lowest level. Use an Application like SunApp from casafok.dk to evaluated obstruction possibility on the solar panel during winter. Make sure there is no shade on the solar panel throughout the day.



Download SunApp



SunApp for IOS



SunApp for Android

Solar Power Unit LED Indications

LED	Indicator	Status
Green LED	On	Solar panel is correctly connected. Battety charged
	Fast Flash (0.1/0.1s)	Smart MPPT charging
	Slow Flash (0.5/2s)	Charging
Yellow LED	Off	Overload protection
	On	Battery is normal
	Slow Flash (0.5/2s)	Battery voltage is low
	Fast Flash (0.5/2s)	Low voltage protection
Red LED	Off	Work normal
	On	The load is off
	Flash (0.5/0.5s)	Overheat protection
	Fast Flash (0.1/0.1s)	Short circuit or over current protection

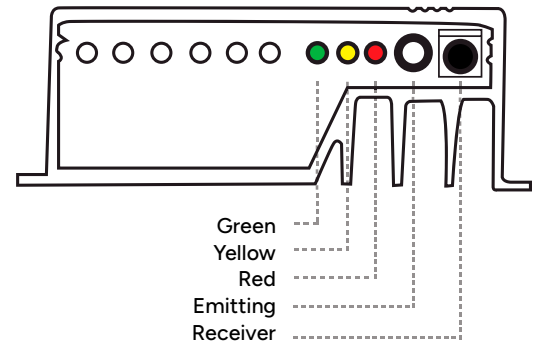

✓ Patented Technology

Solar Power Unit All-In-One



Turn Switch ON. Switch is located in the back of the Solar Power Unit.



Solar panel must face noon sun and avoid shadows on solar panel.



Remove this paper

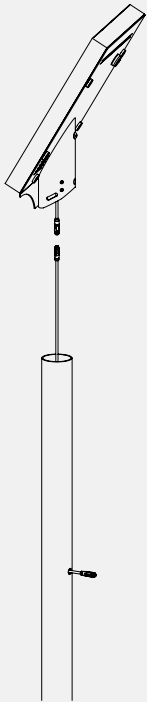

2 3/8" Telespar

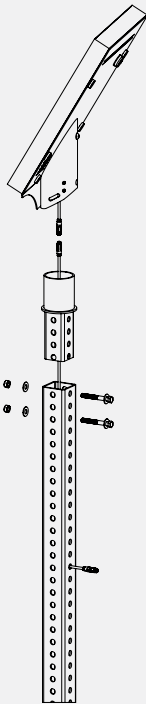

2" Telespar

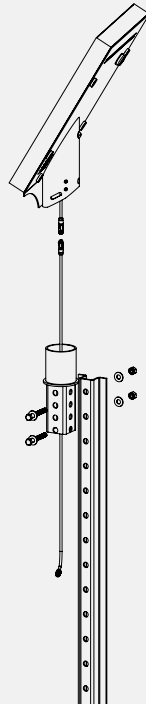

U-Post

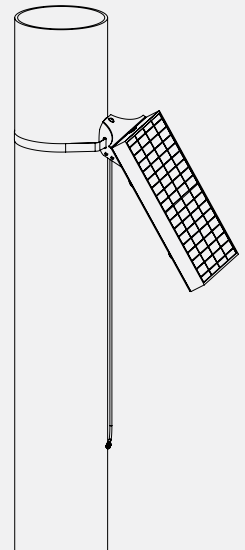

Light Pole



Powered by



Powered by



1 (866) 623-2580
traffic-innovation.com
info@traffic-innovation.com

February, 2025